

User's Guide

Agilent Technologies

ESG Family Signal Generators

Serial Number Prefixes:

(Affix Label Here)



Part No. E4400-90323

Printed in USA
April 2002

© Copyright 1999-2002 Agilent Technologies, Inc.

Contents

1. Preparing for Use

Installing the Signal Generator	1-2
Verifying Signal Generator Operation	1-7
See Agilent Technologies ESG Family Internet Page for the Latest Information	1-10

2. Using Functions

Setting Frequency and Power Levels	2-2
Setting Up Internally Generated Amplitude Modulation	2-5
Setting Up Internally Generated Frequency Modulation	2-7
Creating a Step Sweep and a List Sweep	2-9
Saving and Recalling an Instrument State	2-12
Enabling Options	2-13
If You Encounter a Problem	2-16
Returning a Signal Generator to Agilent Technologies	2-20
Agilent Technologies Sales and Service Offices	2-21

3. Front and Rear Panel

Front Panel Overview	3-2
Display Annotation	3-8
Rear Panel Overview	3-12

4. Hardkey and Softkey Reference

AM	4-2
Ampl	4-13
Amplitude	4-19
Arrow Keys	4-20
Display Contrast Keys	4-21
FM	4-22
Freq	4-34
Frequency	4-38
Help	4-39
Hold	4-40
Incr Set	4-41
I/Q	4-42
LF Out	4-51
Local	4-63
Mod On/Off	4-64
Mode	4-65
Numeric Keypad	4-66
Phase Modulation	4-67
Power Switch	4-80
Preset	4-81
Pulse	4-82
Recall	4-86
Return	4-89
RF On/Off	4-90
Save	4-91
Sweep/List	4-96
Trigger	4-109
Utility	4-111

Contents

5. Memory Structure

Memory Types	5-2
File Storage – the Memory Catalog	5-3

6. Safety and Regulatory

Safety Notes	6-2
Instrument Markings	6-3
General Safety Considerations	6-4
Statement of Compliance	6-5
Assistance	6-6
Certification	6-7
Declaration of Conformity	6-8
Compliance with German Noise Requirements	6-9

1 Preparing for Use

This chapter contains procedures that show you how to install your signal generator and how to perform a functional check to verify signal generator operation. Also, look here for our Internet address for the Agilent Technologies ESG family.

Installing the Signal Generator

This section contains procedures for properly installing your signal generator:

- checking the shipment
- installing front handles and rack flange kits
- meeting electrical and environmental requirements
- adjusting the display
- selecting the signal generator's GPIB address
- selecting the programming language

Checking the Shipment

1. Inspect the shipping container for damage.

Look for signs of damage such as a dented or torn shipping container, or cushioning material that shows signs of unusual stress or compacting.

2. Carefully remove the contents from the shipping container and verify that your order is complete. A power cord and a documentation set are shipped standard with your signal generator. Verify that you have received any options that you ordered.

Installing Front Handles and Rack Mount Flanges

You can attach handles to the front of the signal generator to facilitate transportation of the instrument. Handles are available in a kit which can be ordered when the signal generator is purchased (Option 1CN), or at any time afterward. Assembly instructions are included with the kit. The kit part number is listed in [Table 1-1](#).

You can also rack mount the signal generator. Hardware is available in kits to install rack mount flanges on the signal generator without or with handles. These kits can be ordered when the signal generator is purchased (Options 1CM and 1CP), or at any time afterward. Assembly instructions are included with the kits. The kit part numbers are listed in [Table 1-1](#).

Table 1-1 Front Handle and Rack Mount Flange Kits

Option	Description	Part Number
Option 1CN	Front Handle Kit	5063-9227
Option 1CM	Rack Mount Kit without Handles	5063-9214
Option 1CP	Rack Mount Kit with Handles	5063-9221

Meeting Electrical and Environmental Requirements

Line Settings

CAUTION This product has an autoranging line voltage input. Be sure that the supply voltage is within the specified range.

The available AC power source must meet the following requirements:

Voltage:

- 100/115 volts nominal (90-132 volt range)
- 230/240 volts nominal (198-254 volt range)

Frequency:

- for 100/115 volts: 50/60/400 Hz nominal
- for 230/240 volts: 50/60 Hz nominal

Power:

- 200 watts maximum

WARNING **This is a Safety Class 1 Product (provided with a protective earthing ground incorporated in the power cord). The mains plug shall only be inserted in a socket outlet provided with a protective earth contact. Any interruption of the protective conductor inside or outside of the product is likely to make the product dangerous. Intentional interruption is prohibited.**

CAUTION Always use the three-prong AC power cord supplied with this product. Failure to ensure adequate earth grounding by not using this cord may cause product damage.

Verify that the power cable is not damaged and that the power source socket outlet provides a protective earth contact.

Install the instrument so that the detachable power cord is readily identifiable and is easily reached by the operator. The detachable power cord is the instrument disconnecting device. It disconnects the mains circuits from the mains supply before other parts of the instrument. The front panel switch is only a standby switch and is not a LINE switch.

Alternatively, an externally installed switch or circuit breaker (which is readily identifiable and easily reached by the operator) may be used as a disconnecting device.

Ventilation

CAUTION Ventilation Requirements: When installing the product in a cabinet, the convection into and out of the product must not be restricted. The ambient temperature (outside the cabinet) must be less than the maximum operating temperature of the product by 4 °C for every 100 watts dissipated in the cabinet. If the total power dissipated in the cabinet is greater than 800 watts, then forced convection must be used.

Cooling holes are located on the sides and bottom of the instrument cover and the rear panel of the instrument. Do not allow these holes to be obstructed as they allow air flow through the signal generator.

Environment

This product is designed for use in the following environmental conditions:

- indoor use
- < 15,000 feet (4,572 meters) altitude
- 0 to 55 °C temperature, unless specified differently
- maximum relative humidity 80% for temperatures up to 31 °C, decreasing linearly to 50% relative humidity at 40 °C

CAUTION This product is designed for use in INSTALLATION CATEGORY II and POLLUTION DEGREE 2, per IEC 1010 and 664 respectively.



Proper Usage and Cleaning

The signal generator protects against finger access to hazardous parts within the enclosure, but does not protect against the ingress of water.

WARNING **If this product is not used as specified, the protection provided by the equipment could be impaired. This product must be used in a normal condition only (in which all means for protection are intact).**

WARNING **To prevent electrical shock, disconnect the signal generator from mains before cleaning. Use a dry cloth or one slightly dampened with water to clean the external case parts. Do not attempt to clean internally.**

Adjusting the Display Contrast

You can adjust the contrast of the display by pressing the decrease contrast key  or the increase contrast key . These keys are located on the front panel below the display.

Pressing the decrease contrast key and holding it down causes the display background to gradually darken in comparison to the text on the display. The minimum contrast setting is not a completely black display. Some contrast between the background and the text will still be visible.

Pressing the increase contrast key and holding it down causes the display background to gradually brighten in comparison to the text on the display. If the background does not appear to change, it is probably set to the maximum contrast.

Selecting Inverse Video

The normal display mode for the signal generator is dark text on a light background. To change to inverse video (light text on a dark background), press **Utility > Display** and set **Inverse Video Off On** to **On**. Inverse video is a persistent state; it is not affected by an instrument preset or by a power cycle.

Adjusting the Screen Saver

You can increase the life expectancy of the signal generator's display light by turning on the screen saver. Leaving the display lit for long periods of time or turning the display on and off frequently decreases the life of the bulb. With the screen saver on, the display light is turned off after a defined period of time with no input to the front panel. The display light turns on again when any front panel key is pressed or when a remote command is sent.

The screen saver is set to off at the factory. You can turn it on by pressing **Utility > Display > Screen Saver Off On**. Each time you press **Screen Saver Off On** the selection toggles between **Off** and **On**.

You can adjust the screen saver mode to turn the light on and off or to turn both the light and text on and off. Press **Utility > Display > Screen Saver Mode**. You can toggle between **Light Only** and **Light & Text**. Setting the mode to **Light Only** turns the display light off but leaves the text visible at a low intensity. To prevent the text from burning the display, if you are leaving the display unchanged for long periods of time, set the mode to **Light & Text**. This mode turns the display light and the text off.

The screen saver delay is set to 1 hour at the factory. You can view and change the delay by pressing **Screen Saver Delay** in the same menu. The current screen saver delay is displayed in the softkey label and also in the active entry area. To change the delay, enter a new value using the numeric keypad and then press **Enter**, or rotate the front panel knob. The acceptable range of delay values is 1 through 12 hours in 1 hour increments.

The screen saver settings do not change when **Preset** is pressed, nor when power to the instrument is cycled.

Selecting the Signal Generator's GPIB Address

The signal generator's GPIB address is set to 19 at the factory. You can view and change the address by pressing **Utility > GPIB/RS-232 > GPIB Address**. The current GPIB address is displayed in the softkey label and also in the active entry area. To change the address, enter a new value using the numeric keypad and then press **Enter**, or rotate the front panel knob. The acceptable range of addresses is 0 through 30.

The GPIB address is a persistent state; it is not affected by an instrument preset or by a power cycle.

Selecting the Signal Generator's Programming Language

The default programming language for the signal generator is Standard Commands for Programmable Instruments (SCPI). You can change this language selection by pressing **Utility > GPIB/RS-232 > Remote Language**. The Remote Language menu allows you to select between Agilent 8656/57-compatible language, Agilent 8648-compatible language, and SCPI language. If you have Option UN8, the Remote Language menu allows you to select between Agilent 8656/57-compatible language, Agilent 8657D language (NADC digital modulation capability), Agilent 8657D language (PDC digital modulation capability), and Agilent 8657J (PHS digital modulation capability). Press the softkey for the selection that you desire.

You can also change the language selection by sending the appropriate command over GPIB. Refer to the programming guide for instructions for changing the language over GPIB.

You can set the signal generator to default to a selected language as a persistent state (remains unchanged after an instrument preset or power cycle). Press **Utility > Power On/Preset > Preset Language**. The Preset Language menu allow you to select between SCPI, the Agilent 8656/57-compatible programming languages, and Agilent 8648-compatible language. Press the softkey for the selection that you desire.

Verifying Signal Generator Operation

The operator's check is appropriate as a daily functional check by users, or whenever the integrity of the signal generator is in question. Use the operator's check to verify proper operation of the signal generator. The operator's check does not ensure performance to specifications. To verify specifications, refer to the calibration guide.

Operator's Check

Perform the following tasks in order:

Power On the Signal Generator and Check for Error Messages

This procedure verifies that the signal generator powers up and that the internal instrument check identifies no errors.

1. Turn power on to the signal generator by pressing the power switch. The green LED will light. Let the instrument warm up for one hour.
2. Cycle the power to the signal generator. The green LED should again be lit and the instrument will perform a check.
3. When the display is lit, check to see if the `ERR` annunciator is turned on.
4. If the `ERR` annunciator is turned on, review the error messages in the queue by pressing `Utility > Error Info`. The first error message in the queue will be shown in the text area of the display. Refer to the error messages guide for information about the error message.

If there is more than one error message (each message will be designated as 1 of *n*), press the `View Next Error Message` softkey until you have seen all of the messages.

5. When you have resolved all of the error messages, press `Clear Error Queue(s)` to delete the messages. Then restart this procedure at step two.

NOTE For ESG-AP, ESG-DP, and Option 1E5 signal generators, `ERROR 514, Reference Oven Cold`, will occur whenever the signal generator is first connected to AC line power. The `OVEN COLD` annunciator and the `ERR` annunciator will both turn on. The `OVEN COLD` annunciator will automatically clear after approximately 5 minutes. The error queue *cannot* be cleared, however, until the `OVEN COLD` annunciator has turned off.

Verify Maximum Specified Power is Available at the Maximum Frequency

This procedure verifies that there are no unlevelled power indications or error messages at the maximum specified frequency and power level.

1. Calibrate the power meter with the power sensor. (Refer to the power meter's manual for assistance.)
2. Connect the power sensor to the signal generator's RF OUTPUT connector as shown in [Figure 1-1](#).

Figure 1-1 Operator's Check Equipment Setup

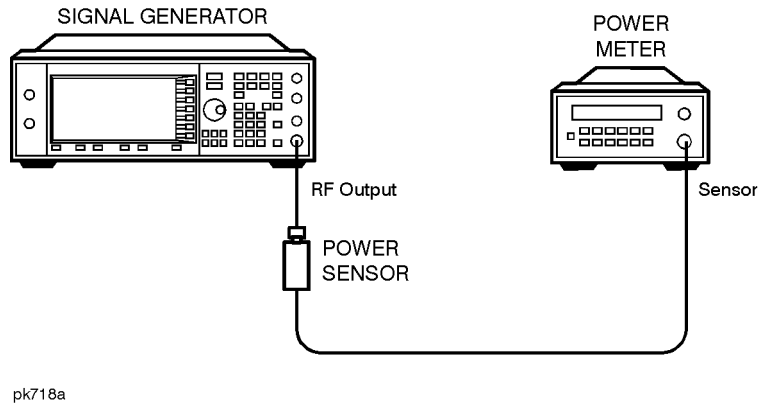

3. Preset the signal generator to the factory-defined conditions:
 - a. Press **Utility > Power On/Preset** and toggle **Preset** until **Normal** is highlighted.
 - b. Press **Preset**.
4. Set the signal generator to its maximum specified frequency:
 - a. Press **Frequency**.
 - b. Use the numeric keypad to enter the signal generator's maximum specified frequency as shown in [Table 1-2](#).
 - c. Terminate your entry by pressing the **GHz** softkey.
5. Set the signal generator to its maximum specified power level:
 - a. Press **Amplitude**.
 - b. Use the numeric keypad to enter the signal generator's maximum specified power level as shown in [Table 1-2](#).
 - c. Terminate your entry by pressing the **dBm** softkey.
6. Toggle the front panel **RF On/Off** key to turn on RF power to the RF OUTPUT connector. The display **RF ON** annunciator will turn on.
7. Verify that the power meter reads the maximum specified output power including the power level accuracy limits.
8. Check to see if the **UNLEVEL** or **ERR** display annunciators have turned on. If these annunciators are on, refer to the service guide for troubleshooting information.

Table 1-2 Frequency and Power Level Limits

ESG Model	Maximum Specified Frequency	Maximum Specified Power	Power Level Accuracy Limits¹
E4400B E4430B E4423B E4434B	1 GHz	+13 dBm	±0.7 dB
E4420B E4431B E4424B E4435B	2 GHz	+10 dBm	±0.7 dB
E4421B E4432B E4425B E4436B	3 GHz	+10 dBm	±1.0 dB
E4422B E4433B E4426B E4437B	4 GHz	+7 dBm	±1.0 dB

1. The values provided are confidence levels only; they are not specifications and may vary with installed options.

See Agilent Technologies ESG Family Internet Page for the Latest Information

Get the latest news, product and support information, application literature and more.
Agilent Technologies Internet address for the ESG family is:
<http://www.agilent.com/find/esg>.

2 Using Functions

This chapter contains procedures that show you how to use some of the major functions of your signal generator including setting frequency and power levels, setting up modulations, creating step and list sweeps, saving and recalling instrument states, and enabling options.

Information is also provided on what you should do if you encounter a problem with your signal generator.

Setting Frequency and Power Levels

Using these procedures, you will learn how to:

- set the RF frequency
- set a frequency reference and a frequency offset
- set the RF output power level
- set an amplitude reference and an amplitude offset

To Set the RF Frequency

1. Turn on power to the signal generator: press the power switch, , so that the green LED is on. The signal generator will perform an internal check.
2. Press the green **Preset** key. The signal generator will return to a set of factory-defined conditions.

NOTE You can change the preset conditions to a user-defined instrument state. However, for the purpose of these examples, use the factory-defined preset state (the **Preset Normal User** softkey in the Utility menu must be set to **Normal**).

3. Observe the frequency area of the display (in the upper left-hand corner). It should display the maximum specified frequency of your signal generator.
4. The signal generator is set to output an RF signal, however the **RF On/Off** key must be set to **On** before the RF signal is available at the RF OUTPUT connector. Press **RF On/Off**. Notice that the display annunciator changes from **RF OFF** to **RF ON**. The maximum specified frequency is now being output at the RF OUTPUT connector.
5. Change the frequency to 700 MHz by pressing **Frequency**. The current RF frequency is now displayed in the active entry area of the display. Using the numeric keypad, enter **700** and then press the **MHz** terminator softkey. The new 700 MHz RF frequency is now displayed in the frequency area of the display and also in the active entry area.
6. Frequency is still the active function until you press another front panel function key. Change the frequency again by pressing the up arrow key once. Each press of the up arrow key increases the frequency by the increment value last set with the **Incr Set** key. The increment value is displayed in the active entry area.

The down arrow works like the up arrow. Practice stepping the frequency up and down in 1 MHz increments. Use the **Incr Set** key to change the increment value to 1 MHz, if necessary.

7. You can also adjust the RF frequency using the front panel knob. As long as frequency is the active function (the frequency is displayed in the active entry area), the front panel knob will increase and decrease the RF frequency. Use the front panel knob to adjust the frequency back to 700 MHz.

To Set a Frequency Reference and a Frequency Offset

The following procedure sets the RF output frequency as a reference frequency to which all other frequency parameters are relative. The frequency initially shown on the display will be 0 Hz (the frequency output by the hardware minus the reference frequency). Although the display changes, the frequency output does not change. Any subsequent frequency changes are shown as incremental or decremental to 0 Hz.

1. Press **Preset** to return the signal generator to the factory-defined instrument state.
2. Set the RF frequency to 700 MHz.
3. Turn on frequency reference mode and set the current output frequency (700 MHz) as the reference value. Press **Freq > Freq Ref Set**. The frequency displayed is 0 Hz (the frequency output by the hardware, 700 MHz, minus the reference value, 700 MHz). Notice that the **REF** indicator is turned on and the **Freq Ref** softkey has toggled to **On**.
4. Set the **RF On/Off** key to **On**. Notice that the display annunciator has changed from **RF OFF** to **RF ON**. The RF frequency at the RF OUTPUT connector is 700 MHz.
5. Increment the output frequency by 1 MHz. Press the up arrow key. The frequency display changes to show 1 MHz (the frequency output by the hardware, 700 MHz + 1 MHz, minus the reference frequency, 700 MHz) and the output frequency changes to 701 MHz.
6. Enter a 1 MHz offset. Press the **Freq Offset** softkey and enter 1 MHz using the numeric keypad and pressing the **MHz** terminator softkey. The frequency display shows 2 MHz (the frequency output by the hardware, 701 MHz, minus the reference frequency, 700 MHz, plus the offset, 1 MHz). Notice that the **OFFSET** indicator is turned on. The frequency at the RF OUTPUT connector is still 701 MHz.

To Set the RF Output Power Level

1. Press **Preset** to return the signal generator to the factory-defined instrument state.
2. Observe the amplitude area of the display (in the upper middle of the display). It should display -135 dBm. This is the normal preset RF output power level.
3. The signal generator is set to output an RF signal, however the **RF On/Off** key must be set to **On** before the RF signal is available at the RF OUTPUT connector. Press **RF On/Off**. Notice that the display annunciator changes from **RF OFF** to **RF ON**. The RF signal is now being output at a -135 dBm level at the RF OUTPUT connector.
4. Change the power level to -20 dBm. Press **Amplitude**. The current power level is now displayed in the active entry area of the display. Using the numeric keypad and the key, enter -20 and then press the **dBm** softkey. The new -20 dBm RF output power is now displayed in the amplitude area of the display and also in the active entry area.
5. **Amplitude** is still the active function until you press another front panel function key. You can also change the amplitude using the up and down arrow keys and the front panel knob. Practice changing the amplitude using these methods also.

To Set an Amplitude Reference and an Amplitude Offset

The following procedure sets the RF output power as an amplitude reference to which all other amplitude parameters are relative. The amplitude initially shown on the display will be 0 dB (the power output by the hardware minus the reference power). Although the display changes, the output power does not change. Any subsequent power changes are shown as incremental or decremental to 0 dB.

1. Press **Preset** to return the signal generator to the factory-defined instrument state.
2. Set the RF output power to -20 dBm.
3. Turn on amplitude reference mode and set the current output power (-20 dBm) as the reference value. Press **Ampl** > **More (1 of 2)** > **Ampl Ref Set**. The amplitude displayed is 0 dB (the power output by the hardware, -20 dBm; minus the reference value, -20 dBm). Notice that the **REF** indicator is turned on and the **Ampl Ref** softkey has toggled to **On**.
4. Set the **RF On/Off** key to **On**. Notice that the display annunciator has changed from **RF OFF** to **RF ON**. The power at the RF OUTPUT connector is -20 dBm.
5. Use the up arrow key to increase the output power by 10 dB. The amplitude display changes to show 10 dB (the power output by the hardware, -20 dBm; $+10$ dBm; minus the reference power, -20 dBm) and the output power changes to -10 dBm.
6. Enter a 10 dB offset. Press the **Ampl Offset** softkey and enter 10 dB using the numeric keypad. The amplitude display shows 20 dB (the power output by the hardware, -10 dBm; minus the reference power, -20 dBm; plus the offset, 10 dB). Notice that the **OFFS** indicator is turned on. The power at the RF OUTPUT connector is still -10 dBm.

Setting Up Internally Generated Amplitude Modulation

Using this procedure, you will learn how to generate an amplitude-modulated signal with the following characteristics:

- carrier frequency set to 1340 kHz
- power level set to 0 dBm
- AM depth set to 90%
- AM rate set to 10 kHz

Setting the Carrier Frequency

1. Preset the signal generator to the factory-defined instrument state.
2. Press the front panel **Frequency** key. Frequency becomes the active function and the normal preset value for frequency is displayed in the active entry area.
3. Enter 1340 kHz using the numeric keypad and pressing the **kHz** terminator softkey. The new carrier frequency is shown in the frequency area of the display. You should see 1.340 000 00 MHz.

Setting the Power Level

1. Press the front panel **Amplitude** key. Amplitude becomes the active function and the normal preset value for amplitude is displayed in the active entry area.
2. Enter 0 dBm using the numeric keypad and pressing the **dBm** terminator softkey. The new power level is shown in the amplitude area of the display. You should see 0.00 dBm.

Setting the AM Depth

1. Press the front panel **AM** key. The first level menu of softkeys is displayed.
2. Press the **AM Depth** softkey. AM depth becomes the active function and the normal preset value for AM depth is displayed in the active entry area.
3. Enter 90% using the numeric keypad and pressing the **%** terminator softkey. The new AM depth is displayed below the **AM Depth** softkey. You should see 90.0 % in the second line of the softkey.

Setting the AM Rate

1. In the same AM menu, press the **AM Rate** softkey. AM rate becomes the active function and the normal preset value for AM rate is displayed in the active entry area.
2. Enter 10 kHz using the numeric keypad and pressing the **kHz** terminator softkey. The new AM rate is displayed below the **AM Rate** softkey. You should see **10.0000 kHz** in the second line of the softkey.

Turning On Amplitude Modulation

The signal generator is now configured to output a 0 dBm, amplitude-modulated carrier at 1340 kHz with the AM depth set to 90% and the AM rate set to 10 kHz. The shape of the waveform is a sinewave (notice that sine is the default for the **AM Waveform** softkey). Follow these remaining steps to output the amplitude-modulated signal.

1. In the same AM menu, press the **AM Off On** softkey. AM toggles from **Off** to **On**. Notice, also, that the **AM** display annunciator is turned on indicating that you have enabled amplitude modulation.
2. Press the front panel **RF On/Off** key to toggle RF on. Notice that the display annunciator changes from **RF OFF** to **RF ON**. The modulated signal is now available at the **RF OUTPUT** connector.

Setting Up Internally Generated Frequency Modulation

Using this procedure you will configure the signal generator to output a frequency-modulated signal with the following characteristics:

- carrier frequency set to 104.9 MHz
- power level set to 0 dBm
- FM deviation set to 75 kHz
- FM rate set to 10 kHz

Setting the Carrier Frequency

1. Preset the signal generator to the factory-defined instrument state.
2. Press the front panel **Frequency** key. Frequency becomes the active function and the normal preset value for frequency is displayed in the active entry area.
3. Enter 104.9 MHz using the numeric keypad and pressing the **MHz** terminator softkey. The new carrier frequency is shown in the frequency area of the display. You should see 104.900 000 00 MHz.

Setting the Power Level

1. Press the front panel **Amplitude** key. Amplitude becomes the active function and the normal preset value for amplitude is displayed in the active entry area.
2. Enter 0 dBm using the numeric keypad and pressing the **dBm** terminator softkey. The new power level is shown in the amplitude area of the display. You should see 0.00 dBm.

Setting the FM Deviation

1. Press the front panel **FM/ΦM** key. The first level menu of FM softkeys is displayed.
2. Press the **FM Dev** softkey. FM deviation becomes the active function and the normal preset value for FM deviation is displayed in the active entry area.
3. Enter 75 kHz using the numeric keypad and pressing the **kHz** terminator softkey. The new FM deviation is displayed below the **FM Dev** softkey. You should see 75.0000 kHz in the second line of the softkey.

Setting the FM Rate

1. In the same FM menu, press the **FM Rate** softkey. FM rate becomes the active function and the normal preset value for FM rate is displayed in the active entry area.
2. Enter 10 kHz using the numeric keypad and pressing the **kHz** terminator softkey. The new FM rate is displayed below the **FM Rate** softkey. You should see **10.0000 kHz** in the second line of the softkey.

Turning On Frequency Modulation

The signal generator is now configured to output a 0 dBm, frequency-modulated carrier at 104.9 MHz with the FM deviation set to 75 kHz and the FM rate set to 10 kHz. The shape of the waveform is a sinewave. (Notice that sine is the default for the **FM Waveform** softkey. Press **More (1 of 2)** to see the softkey.) Follow these remaining steps to output the frequency-modulated signal.

1. In the same FM menu, press the **FM Off On** softkey. FM toggles from **Off** to **On**. Notice, that the **FM** display annunciator is turned on indicating that you have enabled frequency modulation.
2. Press the front panel **RF On/Off** key to toggle RF on. Notice that the display annunciator changes from **RF OFF** to **RF ON**. The modulated signal is now available at the **RF OUTPUT** connector.

Creating a Step Sweep and a List Sweep

Using this procedure, you will learn two ways to set up the signal generator to sweep a defined set of points. You will create a step sweep and then you will use these points as the basis for a new list sweep.

In the first procedure, you will create a step sweep with the following ten, equally spaced points:

- frequency range from 525 MHz to 600 MHz
- power level from –20 dBm to 0 dBm
- dwell time 500 ms at each point

In the second procedure, you will take the step sweep points and edit several points to change the sweep information.

Configuring a Step Sweep

1. Preset the signal generator to the factory-defined instrument state.
2. Press the front panel **Sweep/List** key. The first level of sweep softkeys is displayed. Toggle the **Sweep Type List Step** softkey to **Step**.
3. Press the **Configure Step Sweep** softkey. Another menu is displayed with softkeys that you will use to create the sweep points.
4. Change the start frequency of the step sweep. Press the **Freq Start** softkey. Enter 525 MHz using the numeric keypad and pressing the **MHz** terminator softkey.
5. Change the stop frequency of the step sweep. Press the **Freq Stop** softkey. Enter 600 MHz using the numeric keypad and pressing the **MHz** terminator softkey.
6. Set the power level for the start of the step sweep. Press the **Ampl Start** softkey. Enter –20 dBm using the numeric keypad and pressing the **dBm** terminator softkey.
7. Set the power level for the end of the step sweep. Press the **Ampl Stop** softkey. Enter 0 dBm using the numeric keypad and pressing the **dBm** terminator softkey.
8. Set the number of sweep points. Press the **# Points** softkey. Enter 8 by rotating the front panel knob until the number 8 is displayed.
9. Set the dwell time at each point. Press the **Step Dwell** softkey, then enter 500 ms using the numeric keypad and pressing the **msec** terminator softkey.

Turning On Continuous Step Sweep

1. Press **Return** to move up one menu level.
2. Press the **Sweep** softkey. Another menu is displayed showing you choices for sweeping either the frequency, amplitude, or frequency and amplitude data. Press the **Freq&Ampl** softkey. Selecting this softkey returns you to the previous menu and turns the sweep function on.
3. Press the **Sweep Repeat Single Cont** softkey to toggle from **Single** to **Cont**. Notice that the **SWEEP** display annunciator is turned on indicating that the signal generator is sweeping.
4. Press the front panel **RF On/Off** key to toggle RF on. Notice that the display annunciator changes from **RF OFF** to **RF ON**. The swept RF signal is now available at the **RF OUTPUT** connector.

Configuring a List Sweep Using Step Sweep Data

1. Press the **Sweep Type List Step** softkey to toggle from **Step** to **List**.
2. Press the **Configure List Sweep** softkey. Another menu is displayed with softkeys that you will use to create the sweep points. Notice that the display shows the current list data. (When no list has been previously created, the default is one point set to the signal generator's maximum frequency, -135 dBm, with a dwell time of 2 ms.)
3. Press **More (1 of 2) > Load List From Step Sweep > Confirm Load From Step Sweep**. The points you defined in the step sweep are automatically loaded into the list.

Editing List Sweep Points

1. For point 1, change the dwell time to 100 ms. Press the right arrow key twice until the dwell time is highlighted. Press **More (2 of 2) > Edit Item**. The dwell time for point 1 becomes the active function. Enter 100 ms using the numeric keypad and pressing the **msec** terminator softkey. Note that the next item in the table (in this case, the frequency value for point 2) becomes highlighted after you press the terminator softkey.
2. For point 4, change the frequency to 560 MHz. Using the arrow keys, highlight the frequency. Press the **Edit Item** softkey to make the frequency for point 4 the active function. Enter 560 MHz using the numeric keypad and pressing the **MHz** terminator softkey.
3. Add a new point between points 7 and 8. Highlight any column in the point 7 row. Press **Insert Row**. A copy of the point 7 row is placed between points 7 and 8, creating a new point 8, and renumbering the successive points.
4. Shift frequency values down one row, beginning at point 8. Highlight the frequency item for point 8, then press **Insert Item**. Note that the original frequency values for both points 8 and 9 shift down one row, creating an entry for point 10 that has only a frequency value (the power and dwell time items do not shift down).

5. The frequency for point 8 is still active. Enter 700 and press the **MHz** softkey.

NOTE An informational ERR annunciator turns on to indicate that the frequency and power lists are of unequal size. You will correct this problem in the following steps, however the annunciator does not turn off until you clear the error queue in the Utility menu [**Utility > Error Info > Clear Error Queue(s)**].

6. The power for point 8 should now be highlighted. Press **Insert Item** and change the value to 1 dBm. Inserting a new power value at point 8 shifts down the original power values for points 8 and 9 by one row.
7. Highlight the dwell time for point 9, then press **Insert Item**. A duplicate of the highlighted dwell time is inserted for point 9, shifting the existing value down to complete the entry for point 12.

Turning On List Sweep for a Single Sweep

1. Press **Return** to move up one menu level.
2. Notice that the **Sweep** softkey is still set to sweep both frequency and amplitude data. You do not need to change it.
3. Press the **Sweep Repeat Single Cont** softkey to toggle from **Cont** to **Single**. Notice that the **SWEEP** display annunciator is turned off. The sweep will not occur until it is triggered.
4. Press **Single Sweep**. The signal generator will sweep the points in your list once. Notice that the **SWEEP** display annunciator is turned on during the sweep.
5. Change the sweep trigger to occur when you press **Trigger > More (1 of 2) > Sweep Trigger > Trigger Key**.
6. Press **More (2 of 2) > Single Sweep** to arm the sweep. Notice that the **ARMED** display annunciator has turned on.
7. Press the front panel **Trigger** key. The signal generator will sweep the points in your list once and the **SWEEP** display annunciator is turned on during the sweep.

Saving and Recalling an Instrument State

Using this procedure, you will learn how to save instrument settings to a memory register and to recall the settings.

1. Preset the signal generator to the factory-defined instrument state.
2. Set up the signal generator with the following changes:
 - a. Set the frequency to 800 MHz.
 - b. Set the amplitude to 0 dBm.
 - c. Enable amplitude modulation (AM display annunciator is on).
3. Save this instrument state in the signal generator memory in sequence 1, memory register 01. Press **Save** > **Select Seq**. The sequence number becomes the active function. The signal generator will display the last sequence that you have used. Set the sequence to 1 using the arrow keys.

Press **Select Reg**. The register number in sequence 1 becomes the active function. The signal generator will either display the last register used [accompanied by the text: (in use)] or, if no registers are in use, will display register 00 [accompanied by the text: (available)]. Use the arrow keys to select register 01.

4. Press **Save Seq[1] Reg[01]**. The current instrument settings including the frequency, amplitude, and modulation changes you made have been stored in signal generator memory.
5. Preset the signal generator to the factory-defined instrument state.
6. Recall your instrument state. Press the front panel **Recall** key. Notice that the **Select Seq** softkey shows sequence 1. (This is the last sequence that you have used.) You do not need to change the sequence. Press **RECALL Reg**. The register to be recalled in sequence 1 becomes the active function. Press the up arrow key once to select register 1. Notice that your stored instrument settings have been immediately recalled.

Enabling Options

The ESG Family Signal Generators are a highly flexible platform of instruments that you can retrofit after purchase to add many new capabilities. Some new optional features are implemented in hardware that you must install. Some options are implemented in software but require the presence of optional hardware in the instrument. This example shows you how to enable both hardware and software options.

Enabling a Hardware Option

1. When you purchase a new hardware option for your signal generator, the hardware and instructions for installing the hardware will be included in a kit that you receive. Follow the installation instructions to retrofit your signal generator with the new hardware.
2. Next, on the signal generator press **Utility > Instrument Adjustments > Hardware Options** to access the Hardware Options menu. An example of the signal generator display follows:

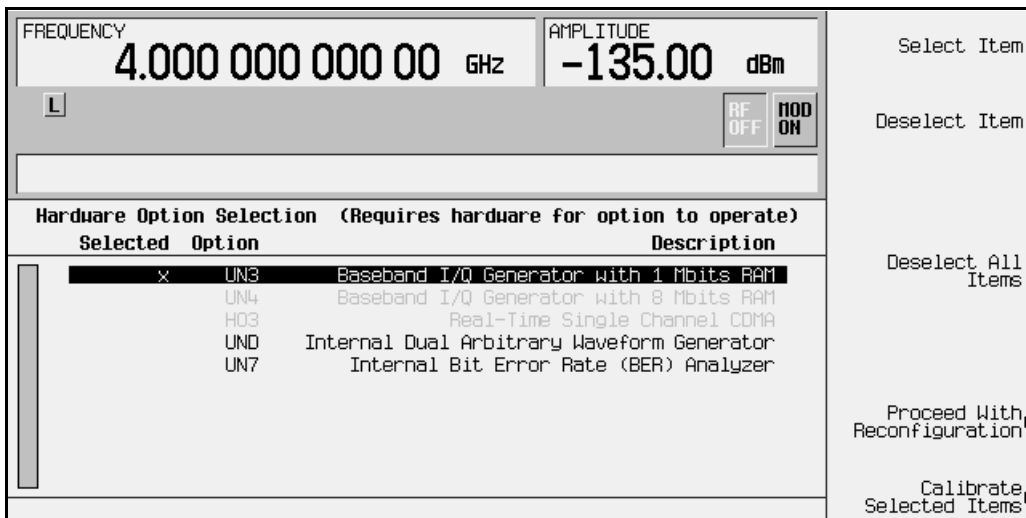

The display indicates which options are currently enabled for the signal generator. In this case Option UN3 is enabled, as indicated by the X placed in the “Selected” column.

3. Highlight the new option that you have just installed. (Use the up/down arrow keys or the front panel knob.)
4. Press **Select Item**. An X will be placed in the “Selected” column.

Two other selection keys are available in this menu to help you identify the proper options to be enabled. **Deselect Item** removes the X from the “Selected” column in the highlighted option. **Deselect All Items** removes all occurrences of the X from the “Selected” column.

5. Press **Proceed With Reconfiguration** to enable all selected options. After pressing this softkey, press **Confirm Change** to verify that you do want to reconfigure the signal generator with the options that you have selected. If you do not want to continue, press **Return**.

CAUTION If you enable an option that does not have the required hardware installed, the menus for that option will be activated but the option *cannot* operate, despite what the menus may seem to indicate.

6. Once you have installed optional hardware in your signal generator, perform a download of calibration data from the hardware into non-volatile memory by pressing **Calibrate Selected Items**. To confirm that you want to start the calibration, press **Start Calibration and Store Results**. The calibration takes several minutes. During the calibration, a message is displayed indicating the calibration is in progress and showing the percent complete. When the calibration is finished, the Hardware Options menu is returned.

Enabling a Software Option

1. A license key is required to enable each software option. This license key is provided on the license key certificate that you receive when you purchase the software option. Access the Software Options menu by pressing **Utility > Instrument Adjustments > Software Options**. An example of the signal generator display follows:

FREQUENCY 4.000 000 000 00 GHz		AMPLITUDE -135.00 dBm		Modify License Key
L		RF OFF		
Software Option Selection		Host ID = 5A172BE3		
Option	License Key	Description		
UN5	472F584F5F9F	Multi-Channel CDMA		
H97	F553502B8C9F	Multi-Channel W-CDMA		
				Proceed With Reconfiguration

Verify that the host ID shown on the display matches the host ID on the license key certificate. The host ID is a unique number for every instrument. If the host ID on the license key certificate does not match your instrument, the license key cannot enable the software option.

2. On the display is a list of software options that are already enabled (if any) and the software options that can be enabled. Software options are linked to specific hardware options. Before a software option can be enabled, the appropriate hardware option must be installed. For example, Option UN5, Multi-Channel CDMA, requires that Option UND, Internal Dual Arbitrary Waveform Generator, be installed. If the software option that you intend to install is listed in a grey font, the required hardware may not be installed. (Look for an X in the “Selected” column of the appropriate hardware option in the Hardware Options menu.)
3. To enable the software option, highlight the desired option using the up/down arrow keys or the front panel knob.
4. Press **Modify License Key**. Enter the 12-character license key (from your license key certificate) using the softkeys and numeric keypad. When you have finished, press the **Enter** terminator softkey.
5. Press **Proceed With Reconfiguration > Confirm Change** to verify that you do want to reconfigure the signal generator with the options for which you have provided a license key. The instrument will enable the options and reboot.

If You Encounter a Problem

If the signal generator is not operating as you expected, look for help in the following list of symptoms and possible solutions. If you do not find a solution here, refer to the service guide.

No RF Output?

The front panel **RF On/Off** key must be set to **On** before the RF signal is available at the RF OUTPUT connector. Check the annunciator on the display. If it reads **RF OFF**, press **RF On/Off** once to toggle the RF output on.

RF Output Power too Low?

If the RF output power seems too low, look for an **OFFSET** or **REF** indicator in the amplitude area of the display.

OFFSET tells you that an amplitude offset has been set. An amplitude offset changes the value shown in the amplitude area of the display but does not affect the output power. The amplitude displayed is equal to the current power output by the signal generator hardware plus the value for the offset. To eliminate the offset, press **Ampl > Ampl Offset**. Enter **0** using the numeric keypad and press the **dB** terminator softkey.

REF tells you that the amplitude reference mode is turned on. When this mode is on, the displayed amplitude value is *not* the output power level; rather, it is the current power output by the signal generator hardware minus the reference value set by the **Ampl Ref Set** softkey. To exit the reference mode, press **Ampl** and toggle the **Ampl Ref** softkey to **Off**. You can then reset the output power to the desired level.

Optional Features are Not Working?

If you enable an option that does not have the required hardware installed, the menus for that option will be activated but the option *cannot* operate, despite what the menus may seem to indicate. Check to be sure that the required hardware is physically installed in the signal generator.

If a software option is disabled but should be enabled, try the following suggestions for resolution:

- Verify that the optional hardware is installed.
- Verify that the hardware option is enabled.
- Verify that the software option is enabled with the correct license key. Refer to your License Key Certificate for the correct license key or, if your option was installed by Agilent Technologies, contact your local service office with the instrument model number, the host ID, and the software option that should be enabled.

No Modulation at the RF Output?

Although you can set up and enable various modulations, the RF carrier is modulated by the enabled modulation only when you have also set **Mod On/Off** to **On**. Check the annunciator on the display. If it reads **MOD OFF**, press the **Mod On/Off** key once to toggle the modulation on.

Can't Turn Off Sweep Mode?

In the sweep mode menu you can choose to set the sweep to various sweep types or to turn sweep off. Press **Sweep/List** > **Sweep** and choose **Off** from the sweep mode selections.

Recalled a Register and Sweep List is Missing?

Sweep information is not stored as part of the instrument state in a storage register. Only the current step and list sweep is available to the signal generator and it cannot be stored nor will it survive a factory preset.

All of the Registers Where You Previously Stored Instrument States are Empty?

The save/recall registers are backed-up by a battery when AC power to the signal generator is not connected. The battery may need to be replaced. To verify that the battery has failed, turn off line power to the signal generator and unplug it. Then plug in the instrument and cycle power on. If either error message **-311** or **-700** is stored in the error message queue, your battery has failed. Refer to the service guide for battery replacement instructions.

Saved an Instrument State in a Register but the Register is Empty or Contains the Wrong State?

If you have intentionally, or unintentionally, selected a register number that is greater than **99**, the signal generator will automatically select register **99** to save your instrument state. If the register number you intended to use is empty or contains the wrong instrument state, recall register **99** as the instrument state may be saved there.

The Power Supply has Shut Down?

If the power supply is not working, it requires repair or replacement. There is no user-replaceable power supply fuse. Refer to the service guide for instructions.

Incorrect List Sweep Dwell Time?

If the signal generator does not dwell for the correct period of time at each sweep list point, first check the sweep list dwell values for accuracy. Press **Sweep/List > Configure List Sweep** and the sweep list values will be displayed. Edit the dwell values if they are incorrect.

NOTE	The effective dwell time at the RF OUTPUT connector is the sum of the value set for the dwell plus processing time, attenuator switching time, and settling time. This additional time added to the dwell is generally a few milli-seconds. The TTL output, however, available at the TRIGGER OUT connector, is asserted high only during the actual dwell time.
-------------	--

If the list dwell values are correct, check to see if the **Dwell Type List Step** softkey is set to **Step**. When **Step** is selected, the signal generator will sweep the list points using the dwell time set for step sweep rather than the sweep list dwell values. To view the step sweep dwell time, press **Configure Step Sweep** and observe the value set for the **Step Dwell** softkey.

Can't Turn Off Help Mode?

There are two help modes (single and continuous) available on the signal generator. In single mode (the factory preset condition) when you press the **Help** key, help text is provided for your next key press. Now press any key and you will exit the help function and the function of the key you pressed is also executed. When you are in continuous help mode, when you press the **Help** key, help text is provided for your next key press and that key's function is also executed (except for the **Preset** key). You will stay in this help mode until you press the **Help** key again. To change from continuous to single mode, press **Utility > Instrument Info/Help Mode** and toggle the **Help Mode Single Cont** softkey to **Single**.

LF OUTPUT Signal is a Sinewave but the RF OUTPUT Signal is a Pulse Squarewave?

The LF OUTPUT connector will output a signal where the frequency and shape is set by the internal source as it is being used by a modulation. However, if you are generating a pulse squarewave, the LF OUTPUT signal is correctly output as a sinewave. That sinewave is later squared by the modulator to generate the pulse modulation.

Signal Generator is Locked Up?

If your signal generator is locked up, try the following suggestions for resolution:

- Make sure that the signal generator is not in remote mode. (The **R** annunciator will be turned on in the display.) Press **Local** to halt remote mode and return to listen mode.
- Make certain that the signal generator is not in a local lockout condition.
- Check for a progress bar on the signal generator display which indicates that an operation is in progress.
- Try an instrument preset.
- Try cycling power.

If none of the previous suggestions resolves the problem, you can try the fail-safe recovery sequence. This sequence should only be used as a last resort as it will reset the signal generator but the process will destroy all user files (instrument state, sequence files, data files), calibration data (unsaved I/Q calibrations, DCFM/DCΦM calibrations), and the persistent state. Do not attempt to perform any other front panel or remote operations during the fail-safe sequence.

To run the fail-safe sequence, hold down the **Preset** key while cycling power. Continue to hold down the **Preset** key until the *ESG fail-safe recovery sequence* message is displayed.

CAUTION Carefully read the entire message! It may list additional risks with the procedure beyond what is documented here.

Release the **Preset** key and press **Yes** to continue with the sequence (or **No** to abort with no lost files).

At the conclusion of the sequence, perform the following steps:

1. Cycle power once again. Cycling power restores all previously installed options. You should expect to see several error messages resulting from calibration files being restored from EEPROM.
2. Perform the DCFM/DCΦM calibration. (Refer to the **DCFm/DCΦM Cal** softkey description in [Chapter 4, “Hardkey and Softkey Reference,”](#) in this manual.)
3. For ESG-D and ESG-DP series signal generators only, perform the I/Q calibration. (Refer to the **I/Q Calibration** softkey description in [Chapter 4, “Hardkey and Softkey Reference,”](#) of this manual.)
4. Agilent Technologies is interested in the circumstances that caused you to have to initiate this procedure. Please contact us at 1-800-452-4844. We'd like to help you eliminate any repeat occurrences.

Returning a Signal Generator to Agilent Technologies

If you are returning your signal generator to Agilent Technologies for servicing, please ship the instrument in the original factory packaging materials. If they are not available, use similar packaging to properly protect the instrument.

Include as much information as possible about the problem: record any error messages that appeared on the display, and include performance test results or any other specific data on the performance of the signal generator.

Return the instrument to the nearest Agilent Technologies sales or service office. A list of sales and service offices follows on the next page.

Agilent Technologies Sales and Service Offices

Table 2-1 Contacting Agilent

Online assistance: www.agilent.com/find/assist

United States (tel) 1 800 452 4844	Latin America (tel) (305) 269 7500 (fax) (305) 269 7599	Canada (tel) 1 877 894 4414 (fax) (905) 282 6495	Europe (tel) (+31) 20 547 2323 (fax) (+31) 20 547 2390
New Zealand (tel) 0 800 738 378 (fax) (+64) 4 495 8950	Japan (tel) (+81) 426 56 7832 (fax) (+81) 426 56 7840	Australia (tel) 1 800 629 485 (fax) (+61) 3 9210 5947	Singapore (tel) 1 800 375 8100 (fax) (65) 836 0252
Malaysia (tel) 1-800 828 848 (fax) 1 800 801 664	Philippines (tel) (632) 8426802 (tel) (PLDT subscriber only): 1 800 16510170 (fax) (632) 8426809 (fax) (PLDT subscriber only): 1 800 16510288	Thailand (tel) outside Bangkok: (088) 226 008 (tel) within Bangkok: (662) 661 3999 (fax) (66) 1 661 3714	Hong Kong (tel) 800 930 871 (fax) (852) 2506 9233
Taiwan (tel) 0800-047-866 (fax) (886) 2 25456723	People's Republic of China (tel) (preferred): 800-810-0189 (tel) (alternate): 10800-650-0021 (fax) 10800-650-0121	India (tel) 1-600-11-2929 (fax) 000-800-650-1101	

3 Front and Rear Panel

This chapter contains descriptions of the keys and connectors and other hardware on the front and rear panels. It also describes which information is displayed in the various parts of the display.

Front Panel Overview

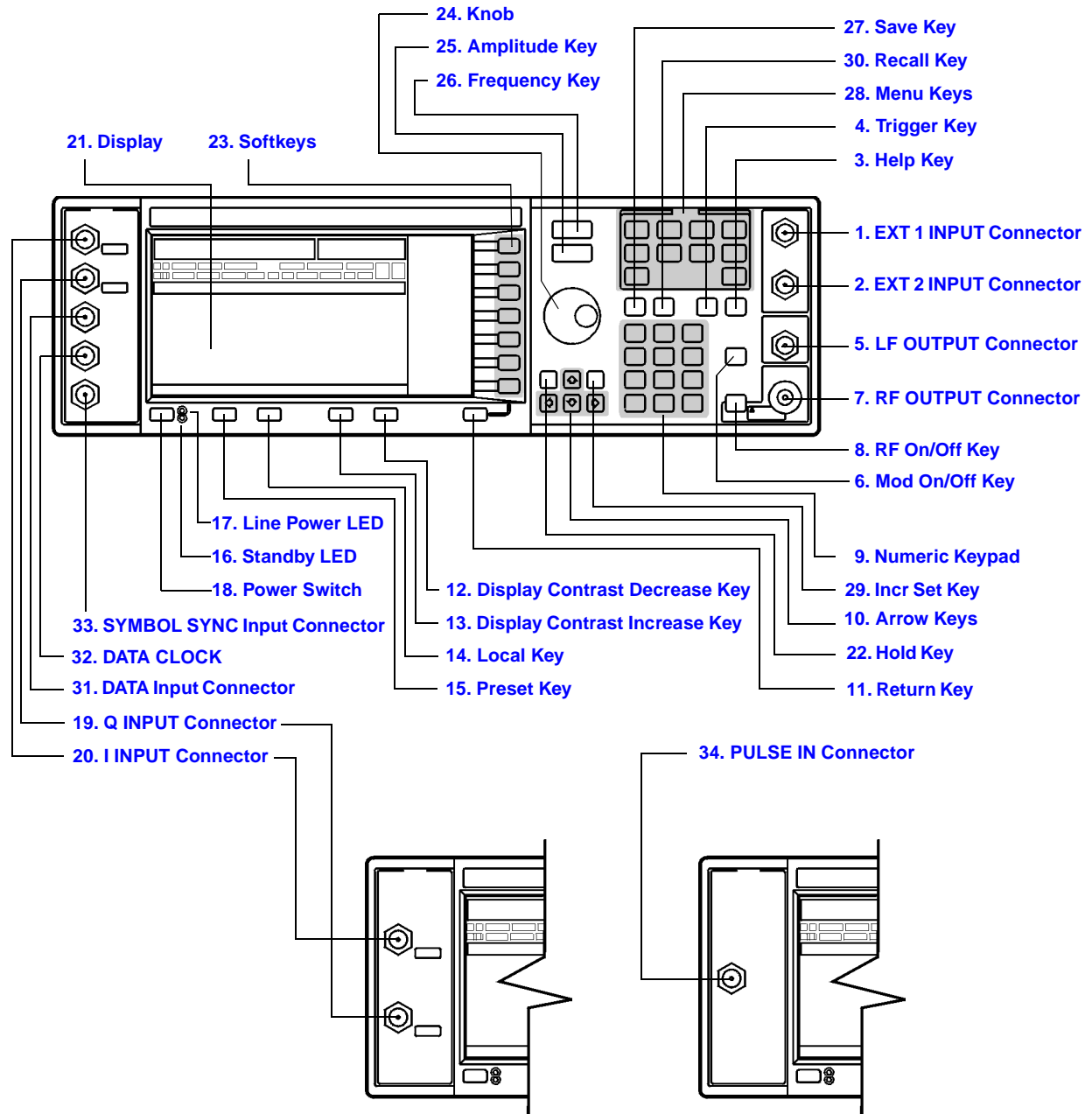

1. EXT 1 INPUT Connector

This female BNC input connector accepts a $1\text{-}V_{pk}$ signal for FM, Φ M, and AM. For all these modulations, $\pm 1 V_{pk}$ produces the indicated deviation or depth. When AC-coupled inputs are selected for FM, Φ M, or AM, HI/LO annunciators will light if the peak input voltage differs from 1.0 V by more than 3%. The input impedance is 50Ω . The damage levels are $5 V_{rms}$ and $10 V_{pk}$. If you configure your signal generator with Option 1EM, this input is relocated to a rear panel, female BNC connector.

2. EXT 2 INPUT Connector

This female BNC input connector accepts a $1\text{-}V_{pk}$ signal for FM, Φ M, AM, and pulse modulation. With FM, Φ M, or AM, $\pm 1 V_{pk}$ produces the indicated deviation or depth. With pulse modulation, +1 V is on and 0 V is off. When AC-coupled inputs are selected for FM, Φ M, or AM, HI/LO annunciators will light if the peak input voltage differs from 1.0 V by more than 3%. The input impedance is 50Ω . The damage levels are $5 V_{rms}$ and $10 V_{pk}$. If you configure your signal generator with Option 1EM, this input is relocated to a rear panel, female BNC connector.

3. Help Key

Press this hardkey for a short textual description of the function of the front panel hardkeys and softkeys. Press this key again and you will be returned to normal instrument operation.

4. Trigger Key

Press this hardkey to begin an event (such as a step or list sweep). This key must first be selected as the method for activating an event by pressing the **Trigger Key** softkey, located in the softkey menus associated with the event.

5. LF OUTPUT Connector

This female BNC connector is the output connector for modulation signals generated by the LF (low frequency) source function generator. You can also output signals where the frequency and shape are set by the internal source as it is being used by a modulation. For pulse modulation, however, the internal source is a sine wave that is later squared by the modulator to generate the pulse square wave.

This output is capable of driving $3.5 V_{pk}$ into a 50Ω load. If you configure your signal generator with Option 1EM, this input is relocated to a rear panel, female BNC connector.

6. Mod On/Off Key

This hardkey toggles all modulation signals on and off. Although you can set up and enable various modulation states, the RF carrier is not modulated until **Mod On/Off** is set to **On**. An annunciator is always turned on in the display to indicate whether modulation is turned on or off.

7. RF OUTPUT Connector

This female Type-N connector is the output connector for RF signals. The source impedance is 50Ω. The damage levels are 50 Vdc, 50 W at ≤ 2 GHz, and 25 W at > 2 GHz maximum. The reverse power protection circuit will trip, however, at nominally 1 watt. If you configure your signal generator with Option 1EM, this output is relocated to a rear panel, female Type-N connector.

8. RF On/Off Key

This hardkey toggles the RF signal on and off at the RF OUTPUT connector. An annunciator is always turned on in the display to indicate whether RF is turned on or off.

9. Numeric Keypad

The numeric keypad consists of the digit keys (0 through 9), a decimal point key, and a backspace key, . The backspace key has dual functions for both backspacing and for changing the sign of a value between positive and negative. Use these keys whenever the active function requires a value input.

10. Arrow Keys

The up and down arrow keys increase or decrease a numeric value. You can also use these keys to scroll through displayed lists to select items. The left and right arrow keys choose the highlighted digit in the active function display; that digit can be modified by the up and down arrow keys or the knob. You can also use these keys in a list to select items in a row.

11. Return Key

The Return key cancels the current active function and moves you from your current softkey menu to the softkey menu that precedes it. It will back up through the menus of the current hardkey until you reach the first menu of that key.

12. Display Contrast Decrease Key

Press this key and hold it down to cause the display background to darken in comparison to the text on the display.

13. Display Contrast Increase Key

Press this key and hold it down to cause the display background to brighten in comparison to the text on the display.

14. Local Key

Press this key to return the signal generator to local (front panel) control from remote operation.

15. Preset Key

Press this key to set the signal generator to a known state (either the factory-defined state or a user-defined state).

16. Standby LED

This yellow LED lights when the instrument is in standby condition. In standby, the power switch is off but the instrument is still connected to the main power circuit by way of the power cord.

17. Line Power LED

This green LED lights when power is cycled on to the signal generator.

18. Power Switch

Press this hardkey to turn power to the signal generator either on (green LED on) or to standby (yellow LED on).

19. Q INPUT Connector

This connector accepts an externally supplied, analog, quadrature-phase component of I/Q modulation. The signal level is $\sqrt{I^2+Q^2} = 0.5 V_{\text{rms}}$ for a calibrated output level. The input impedance is 50Ω. The damage level is 1 V_{rms}. This female BNC connector is provided only on ESG-D and ESG-DP Series Signal Generators. If you configure your instrument with Option 1EM, this input is relocated to a rear panel, female BNC connector.

20. I INPUT Connector

This connector accepts an externally supplied, analog, in-phase component of I/Q modulation. The signal level is $\sqrt{I^2+Q^2} = 0.5 V_{\text{rms}}$ for a calibrated output level. The input impedance is 50Ω. The damage level is 1 V_{rms}. This female BNC connector is provided only on ESG-D and ESG-DP Series Signal Generators. If you configure your instrument with Option 1EM, this input is relocated to a rear panel, female BNC connector.

21. Display

The LCD display provides information on the current instrument state such as modulation status, frequency and amplitude settings, status indicators, and error messages. Softkey labels corresponding to their adjacent keys are located on the right-hand side of the display. For details about the display, see “[Display Annotation](#)” on page 3-8.

22. Hold Key

Press this hardkey to deactivate the currently active function and blank the softkey menu. Once **Hold** is pressed, the front panel knob, the arrow keys, and the numeric keypad have no effect. To return to normal operation, press a function or menu hardkey.

23. Softkeys

Press a softkey to activate the function indicated by the corresponding label on the display.

24. Knob

The knob increases or decreases a numeric value. Any of the values that can be set through the numeric keypad or the step keys can also be set by the knob.

25. Amplitude Key

Press this hardkey to activate the power level amplitude function so that you can change the amplitude of the RF output.

26. Frequency Key

Press this hardkey to activate the frequency function so that you can change the frequency of the RF output.

27. Save Key

This hardkey lets you save up to 100 different instrument states in a combination of 100 memory registers and 10 register sequences. The number of states you can save, however, is limited by the size of whatever else is stored in the file system.

28. Menu Keys

These hardkeys provide access to the signal generator's primary functionality. Press these keys for access to softkey menus where you can configure modulations, step and list sweeps, and various frequency and power capabilities.

29. Incr Set Key

Press this hardkey to toggle between the current active function and the increment size for that function. With increment size selected, you can change the current increment value.

30. Recall Key

This hardkey lets you restore any instrument state that you previously saved in a memory register. You can save up to 100 different instrument states in a combination of 100 memory registers and 10 register sequences. The number of states you can save, however, is limited by the size of whatever else is stored in the file system.

31. DATA Input Connector

The TTL/CMOS compatible DATA connector accepts an externally supplied data input for digital modulation applications. The expected input is a TTL or CMOS signal where a CMOS high is equivalent to a data 1 and a CMOS low is equivalent to a data 0.

The maximum input data rate is 50 Mb/s if the user supplies the data. If the signal generator is supplying any of the data, the maximum rate is 5 Mb/s. The leading edges must be synchronous with the DATA CLOCK rising edges. The data must be valid on the DATA CLOCK falling edges. The damage levels are $> +8$ and $< -4V$.

This female BNC connector is provided on instruments with Option UN8. It is also present *but not functional* on instruments with Option UND. On instruments with Option 1EM, this input is relocated to a rear panel SMB connector.

32. DATA CLOCK Input Connector

The TTL/CMOS compatible DATA CLOCK connector accepts an externally supplied data-clock input for digital modulation applications. The expected input is a TTL or CMOS signal (either bit or symbol) where the rising edge is aligned with the beginning data bit. The CMOS falling edge is used to clock the DATA and SYMBOL SYNC signals.

The maximum clock rate is 50 MHz if the user supplies the data. If the signal generator is supplying any of the data, the maximum rate is 5 MHz. The damage levels are $> +8$ and $< -4V$.

This female BNC connector is provided on instruments with Option UN8. It is also present *but not functional* on instruments with Option UND. On instruments with Option 1EM, this input is relocated to a rear panel SMB connector.

33. SYMBOL SYNC Input Connector

The CMOS compatible SYMBOL SYNC connector accepts the digital-modulation symbol synchronization signal from an external source. This signal synchronizes the serial multi-bit symbol transmission. The expected signal may be continuous or a single, one-bit wide pulse to synchronize the first bit of the first symbol. The CMOS rising edge must be synchronous with the DATA CLOCK rising edges. The synchronization signal must be valid on the DATA CLOCK falling edges. The damage levels are $> +8$ and $< -4V$.

This female BNC connector is provided on instruments with Option UN8. It is also present *but not functional* on instruments with Option UND. On instruments with Option 1EM, this input is relocated to a rear panel SMB connector.

34. PULSE IN Connector

This connector accepts an externally supplied TTL-compatible pulse signal. The pulse signal is activated with the **Fast Pulse Off On** softkey or via SCPI command. The maximum input for this connector is ± 15 volts. This female BNC connector is provided only on instruments with Option 1E6.

Display Annotation

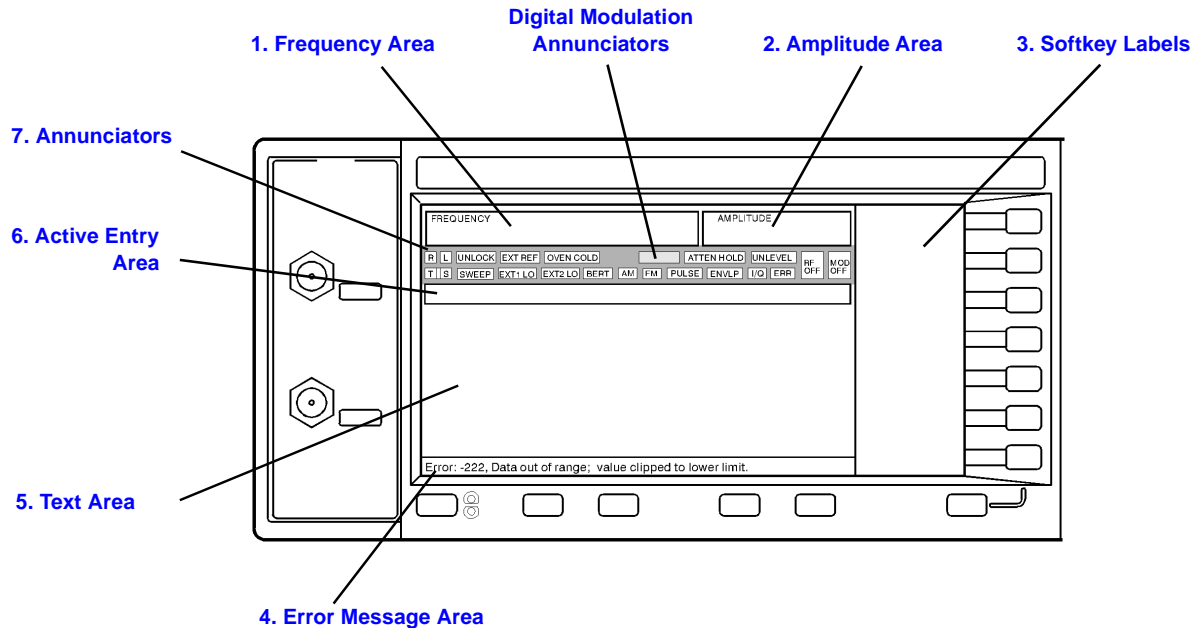

1. Frequency Area

The current CW frequency setting is shown in this portion of the display. Indicators are also displayed in this area when a frequency offset or multiplier is set or if frequency reference mode is turned on.

2. Amplitude Area

The current output power level setting is shown in this portion of the display. Indicators are also displayed in this area when an amplitude offset is set or if amplitude reference mode is turned on.

3. Softkey Labels

These labels define the function of the corresponding softkeys immediately to the right of the label.

4. Error Message Area

Abbreviated error messages are reported in this space. When multiple error messages occur, only the most recent message remains displayed. All of the reported error messages with details can be viewed by pressing **Utility > Error Info > View Next Error Message**.

5. Text Area

This area is used to display status information about the signal generator such as the modulation status, to enter information such as creating sweep lists, and to manage information such as displaying the catalog of files and deleting unwanted files.

6. Active Entry Area

The current active function is shown in this area. For example, if frequency is the active function, the current setting will be displayed in the active entry area and that setting will change as you enter a new value. If the active function has an increment value associated with it, that value is displayed here also.

7. Annunciators

The display annunciators described in the following list show the status of some of the signal generator functions, and indicate any error conditions. An annunciator position may be used by more than one annunciator, as with the digital modulation annunciators. This does not cause a problem, because only one of the functions, that shares a location can be active at a time.

Φ M	This annunciator appears when phase modulation is turned on. A second annunciator, FM, will appear in the same position if frequency modulation is turned on. Frequency modulation and phase modulation cannot be turned on at the same time, so the two annunciators will never conflict.
ALC OFF	This annunciator appears when the automatic leveling control (ALC) circuit is disabled. A second annunciator, UNLEVEL, will appear in the same position if the signal generator's automatic level control is unable to maintain the output level. When the ALC is disabled, the unlevelled annunciator has no meaning, so these annunciators will never conflict.
AM	This annunciator appears when amplitude modulation is turned on.
ARMED	This annunciator appears when a sweep has been initiated and the signal generator is waiting for the sweep trigger event.
ATTEN HOLD	This annunciator appears when the attenuator hold function is turned on. When this function is on, the attenuator is frozen at its current setting.
BERT	This annunciator appears whenever the Option UN7, bit error rate test (BERT), or Option 300, base station BERT extension, functions are turned on.
Digital Modulation Annunciators	All digital modulation annunciators appear in the same position, but there is no conflict because only one of these functions can be active at any given time.
ENVLP	This annunciator appears if the burst envelope modulation is turned on. This annunciator is present only on ESG-D and ESG-DP Series Signal Generators.

ERR	This annunciator appears when an error message is placed in the error queue. This annunciator will not turn off until you have either viewed all of the error messages or cleared the error queue. You can view and delete error messages using the Utility menu.
EXT1 LO/HI	This annunciator toggles between EXT1 LO and EXT1 HI. This annunciator appears if the AC-coupled signal to the EXT 1 input is less than $0.97 V_{pk}$ or greater than $1.03 V_{pk}$.
EXT2 LO/HI	This annunciator toggles between EXT2 LO and EXT2 HI. This annunciator appears if the AC-coupled signal to the EXT 2 input is less than $0.97 V_{pk}$ or greater than $1.03 V_{pk}$.
EXT REF	This annunciator appears when an external 1, 2, 5, or 10 MHz frequency reference is in use.
FM	This annunciator appears when frequency modulation is turned on. A second annunciator, Φ_M , will appear in the same position if phase modulation is turned on. Frequency modulation and phase modulation cannot be turned on at the same time, so the two annunciators will never conflict.
I/Q	This annunciator appears when I/Q modulation is turned on. This annunciator is present only on ESG-D and ESG-DP Series Signal Generators.
L	The L annunciator appears when the signal generator is in the listen mode and receiving information or commands over the GPIB or RS-232.
MOD OFF	This annunciator toggles between MOD OFF and MOD ON and is always visible in the display. This annunciator indicates whether the modulations that you have enabled are modulating the RF carrier.
OVEN COLD	This annunciator appears when the temperature of the internal ovenized reference oscillator (ESG-AP, ESG-DP, and Option 1E5) has dropped below an acceptable level. When this annunciator is on, frequency accuracy is degraded. This condition should occur only if the signal generator is disconnected from line power. The annunciator is timed, and automatically turns off after a specified period.
PULSE	This annunciator appears when pulse modulation is turned on.
R	The R annunciator appears when the signal generator is in remote GPIB operation.
RF OFF	This annunciator toggles between RF OFF and RF ON and is always visible in the display. This annunciator indicates whether the RF signal is present at the RF OUTPUT connector.
S	The s annunciator appears when the signal generator has generated a service request (SRQ) over the GPIB.
SWEEP	This annunciator appears when the signal generator is sweeping in list or step mode.

T	The T annunciator appears when the signal generator is in the talk mode and is transmitting information over the GPIB or RS-232.
UNLEVEL	This annunciator appears when the signal generator is unable to maintain the correct output level. The UNLEVEL annunciator is not necessarily an indication of instrument failure. Unleveled conditions can occur during normal operation, for example if I/Q modulation is turned on and no I/Q signals are connected. A second annunciator, ALC OFF, will appear in the same position when the automatic leveling control circuit is disabled. When the ALC is disabled, the UNLEVEL annunciator has no meaning, so these annunciators will never conflict.
UNLOCK	This annunciator appears when any of the signal generator's phase locked loops are unable to maintain phase lock. You can determine which loop is unlocked by interrogating the error messages.

Rear Panel Overview

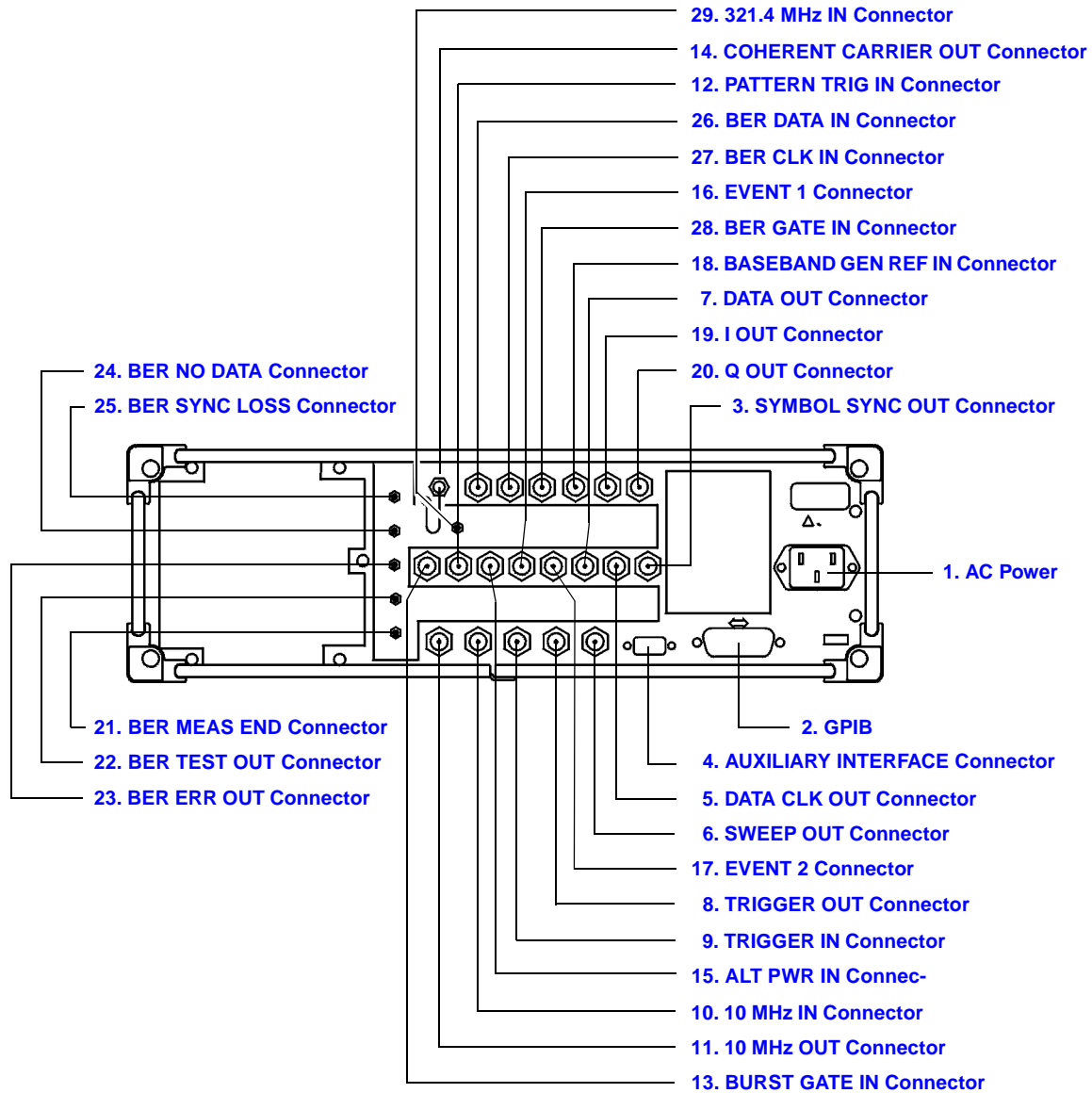

1. AC Power Receptacle

The power cord receptacle accepts a three-pronged cable that is shipped with the instrument. The line voltage is connected here.

2. GPIB Connector

The GPIB connector allows communications with compatible devices such as external controllers. It is functionally equivalent to the AUXILIARY INTERFACE connector.

3. SYMBOL SYNC OUT Connector

The TTL/CMOS compatible SYMBOL SYNC OUT connector outputs a symbol synchronization pulse, one data clock period wide, for use in digital modulation applications. The pulse output is synchronized with the first symbol in the internal pattern generator sequence. The damage levels are $> +8$ and < -4 V. This female BNC connector is provided only on instruments with Option UND or UN8. If you configure your instrument with Option 1EM, this output is changed from a BNC to an SMB connector. With Option 201 you can select from several different output signals for this connector.

4. AUXILIARY INTERFACE Connector

This male DB-9 connector is an RS-232 serial port that can be used for controlling the signal generator remotely. It is functionally equivalent to the GPIB connector. The following table shows the description of the pinouts.

Pin Number	Signal Description	Signal Name
1	No Connection	
2	Receive Data	RECV
3	Transmit Data	XMIT
4	+5 V	
5	Ground, 0 V	
6	No Connection	
7	Request to Send	RTS
8	Clear to Send	CTS
9	No Connection	

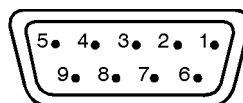

View looking into
rear panel connector

pk763a

5. DATA CLK OUT Connector

The DATA CLK OUT connector outputs a clock signal for digital modulation data. The output signal level is TTL or CMOS with the rising edge aligned with the beginning of the data bit and the falling edge occurring when the data and symbol synchronization signal are valid. The damage levels are $> +8$ and < -4 V. This female BNC connector is provided only on instruments with Option UND or UN8. If you configure your instrument with Option 1EM, this output is changed from a BNC to an SMB connector. With Option 201 you can select from several different output signals for this connector.

6. SWEEP OUT Connector

This female BNC connector provides a voltage range of 0 to +10 V. When the signal generator is sweeping, the SWEEP OUT signal ranges from 0 V at the beginning of the sweep to +10 V at the end of the sweep regardless of the sweep width. In CW mode this connector has no output. The output impedance is less than 1Ω and can drive $2\text{ k}\Omega$.

7. DATA OUT Connector

The DATA OUT connector outputs digital modulation data sourced from an externally supplied signal at the DATA input or from the internal pattern generator. The output signal level is a TTL or CMOS signal where a CMOS high is equivalent to a data 1 and a CMOS low is equivalent to a data 0. This female BNC connector is provided only on instruments with Option UND or UN8. If you configure your instrument with Option 1EM, this output is changed from a BNC to an SMB connector. With Option 201 you can select from several different output signals for this connector.

8. TRIGGER OUT Connector

This female BNC connector outputs a TTL signal that is asserted high at the start of a dwell sequence, or at the start of waiting for the point trigger in manual sweep mode, and low when the dwell is over, or when the point trigger is received, or once per sweep during an LF sweep. The logic polarity can be reversed.

9. TRIGGER IN Connector

This female BNC connector accepts a TTL signal for triggering operations, such as point-to-point in manual sweep mode or an LF sweep in external sweep mode. Triggering can occur on either the positive or negative edge. The damage level is $\geq +10$ V or ≤ -4 V.

10. 10 MHz IN Connector

This female BNC connector accepts a -3.5 to $+20$ dBm signal from an external timebase reference that is within ± 10 ppm (standard timebase) or ± 1 ppm (high stability timebase). The nominal input impedance is 50Ω . The signal generator detects when a valid reference signal is present at this connector and automatically switches from internal to external reference operation.

11. 10 MHz OUT Connector

This female BNC connector provides a nominal signal level of $+7$ dBm ± 2 dB, and an output impedance of 50Ω . The accuracy is determined by the timebase used.

12. PATTERN TRIG IN Connector

This input can accept either a TTL/CMOS low to TTL/CMOS high or TTL/CMOS high to TTL/CMOS low edge trigger. The minimum trigger input pulse width, high or low, is 100 ns. The damage levels are $> +8$ and < -4 V. This female BNC connector is provided only on instruments with Option UN8 or UND. If you configure your instrument with Option 1EM, this input is changed from a BNC to an SMB connector.

With Option UN8 turned on, the input to the PATTERN TRIG IN connector is used to trigger the internal digital modulation pattern generator to start a single pattern output or to stop and re-synchronize a pattern that is being continuously output. The trigger edge is latched and then sampled by the falling edge of the internal data bit clock to synchronize the trigger with the data bit clock timing. The minimum delay from the trigger edge to the first bit of the frame is 1.5 to 2.5 bit clock periods. For more information on pattern triggering, refer to the “Operation” chapters in the user’s and programming guides.

With Option UND turned on, this connector is the source for the external trigger for all of the ARB waveform generator triggers. With Option 201 this connector is used for system reset trigger input.

13. BURST GATE IN Connector

The BURST GATE IN connector accepts a TTL or CMOS signal for gating burst power in digital modulation applications. The burst gating is used when you are externally supplying data and clock information. The input signal must be synchronized with the external data input that will be output during the burst. The burst power envelope and modulated data are internally delayed and re-synchronized. The input signal must be CMOS high for normal burst RF power or CW RF output power and CMOS low for RF off. The leading edges must be synchronous with the DATA CLOCK rising edges. The signal level must be valid on the DATA CLOCK falling edge. The damage levels are $> +8$ and < -4 V. This female BNC connector is provided only on instruments with Option UND or UN8. If you configure your instrument with Option 1EM, this output is changed from a BNC to an SMB connector. With Option 201 this connector is used for even second synchronization input.

14. COHERENT CARRIER OUT Connector

This connector outputs RF that is not modulated with AM, pulse, or I/Q modulation, but is modulated with FM or Φ M. The output power is nominally 0 dBm \pm 5 dB. The output frequency range is from 249.99900001 MHz to the maximum specified frequency of your signal generator. If the RF output frequency is below this range, the COHERENT CARRIER OUT signal will have the following frequency: Frequency of coherent carrier = $(1E9 - \text{Frequency of RF output})$ in Hz. The damage levels are 20 Vdc and 13 dBm reverse RF power. This SMA connector is present only on ESG-D and ESG-DP Series Signal Generators.

15. ALT PWR IN Connector

This BNC connector accepts a CMOS signal for synchronization of external data and alternate power signal timing. Damage levels are $> +8$ V and < -4 V. This connector is active only with Options UNA or 201. With Option 201 this connector is used for Long Code State Latch strobe input.

16. EVENT 1 Connector

With Option UN8 turned on, this TTL/CMOS compatible connector outputs a pulse that can be used to trigger the start of a data pattern, frame, or timeslot. It is adjustable to within plus or minus one timeslot with one bit of resolution. With Option UN5 turned on (Option UN5 requires Option UND hardware), an even second output is generated. A marker is output every two seconds indicating the beginning of each short code sequence for use in synchronizing CDMA analysis instruments.

With Option UND turned on, there is a marker on/off condition associated with each waveform point. A marker (TTL high when positive polarity is selected; TTL low when negative polarity is selected) is output on the EVENT 1 connector whenever a Marker 1 is turned on in the waveform. (Markers are automatically turned on whenever you set them in a waveform segment. When you combine waveform segments that contain Marker 1 into a sequence, the markers are automatically turned off until you toggle them on in either the Edit Selected Waveform Sequence menu or in the Build New Waveform Sequence menu.)

The damage levels for this connector are $> +8\text{ V}$ and $< -4\text{ V}$. This female BNC connector is provided only on instruments with Option UN8 or UND. If you configure your instrument with Option 1EM, this output is changed from a BNC to an SMB connector. With Option 201 you can select from several different output signals for this connector.

17. EVENT 2 Connector

With Option UN8 turned on, this TTL/CMOS compatible connector outputs a data enable signal for gating external equipment. The output is applicable when the external data is clocked into internally generated timeslots. Data is enabled when the signal is low. With Option UN5 turned on (Option UN5 requires Option UND hardware), a marker is output on the EVENT 2 connector every 26.67 milliseconds, corresponding to the start of each short code.

With Option UND turned on, there is a marker on/off condition associated with each waveform point. A marker (TTL high when positive polarity is selected; TTL low when negative polarity is selected) is output on the EVENT 2 connector whenever a Marker 2 is turned on in the waveform. (Markers are automatically turned on whenever you set them in a waveform segment. When you combine waveform segments that contain Marker 2 into a sequence, the markers are automatically turned off until you toggle them on in either the Edit Selected Waveform Sequence menu or in the Build New Waveform Sequence menu.)

The damage levels are $> +8\text{ V}$ and $< -4\text{ V}$. This female BNC connector is provided only on instruments with Option UN8 or UND. On instruments with Option 1EM, this output is changed from a BNC to an SMB connector. With Option 201 this connector is used for system reset output.

18. BASEBAND GEN REF IN Connector

With Option UN8 enabled, the BASEBAND GEN REF IN connector accepts a 0 to +20 dBm sinewave or TTL squarewave signal from an external 13 MHz timebase reference. This digital modulation reference clock is used by the internal pattern generator in GSM applications (only the *internal* digital data generator can be locked to this external reference; the RF frequency remains locked to the 10 MHz reference). The nominal input impedance is 50Ω at 13 MHz, AC-coupled.

With Option UND enabled, this connector accepts a TTL or > -10 dBm sinewave external reference at rates from 250 kHz through 20 MHz. The internal clock for the arbitrary waveform generator is locked to this signal when external reference is selected in the ARB setup. The minimum pulse width must be > 10 ns. The damage levels are > +8V and < -8V.

This female BNC connector is provided only on instruments with Options UND or UN8. On instruments with Option 1EM, this output is changed from a BNC to an SMB connector.

19. I OUT Connector

The I OUT connector outputs the analog, in-phase component of I/Q modulation from the internal baseband generator. The nominal output impedance of this connector is 50Ω, DC-coupled. The damage levels are > +2 V and < -2 V. The DC origin offset is typically < 10 mV. The output signal levels into a 50Ω load are as follows:

- 0.5 V_{pk}, typical, corresponds to one unit length of the I/Q vector.
- 0.69 V_{pk} (2.84 dB), typical, maximum crest factor for peaks for $\pi/4$ DQPSK with $\alpha = 0.5$.
- 0.71 V_{pk} (3.08 dB), typical, maximum crest factor for peaks for $\pi/4$ DQPSK with $\alpha = 0.35$.
- Typically 1 V_{p-p} maximum (Option UND only).

This female BNC connector is provided only on instruments with Option UND or UN8. If you configure your instrument with Option 1EM, this output is relocated from a BNC to an SMB connector.

20. Q OUT Connector

The Q OUT connector outputs the analog, quadrature-phase component of I/Q modulation from the internal baseband generator. The nominal output impedance of this connector is 50 Ω , DC-coupled. The damage levels are > +2 V and < -2 V. The DC origin offset is typically < 10 mV. The output signal levels into a 50 Ω load are as follows:

- 0.5 V_{pk}, typical, corresponds to one unit length of the I/Q vector.
- 0.69 V_{pk} (2.84 dB), typical, maximum crest factor for peaks for $\pi/4$ DQPSK with $\alpha = 0.5$.
- 0.71 V_{pk} (3.08 dB), typical, maximum crest factor for peaks for $\pi/4$ DQPSK with $\alpha = 0.35$.
- Typically 1 V_{p-p} maximum (Option UND only).

This female BNC connector is provided only on instruments with Option UND or UN8. If you configure your instrument with Option 1EM, this output is relocated from a BNC to an SMB connector.

21. BER MEAS END Connector

The BER MEAS END connector outputs a signal that indicates the status of the bit-error-rate (BER) measurements. BER measurements are being executed when the signal is high. The damage levels are > +8 and < -4 V. This female SMB connector is provided only on instruments with Option UN7.

22. BER TEST OUT Connector

The BER TEST OUT connector outputs a signal that indicates the test result of the pass/fail judgement of the bit-error-rate measurements. The result is guaranteed at the falling edge of the signal of the MEAS END connector. The result is pass when the signal is low; the result is fail when the signal is high. The signal is also high when the pass/fail judgement is set to off. The damage levels are > +8 and < -4 V. This female SMB connector is provided only on instruments with Option UN7.

23. BER ERR OUT Connector

The output of the BER ERR OUT connector is normally low. When the maximum data rate mode is set to 2 Mbps, the BER ERR OUT connector outputs pulse signals that indicate errors. One pulse with a width of about 80 ns indicates one error bit. Pulses indicating errors are asynchronous to the BER CLK IN and are only valid during BER measurements (when BER MEAS END is high). The damage levels are > +8 and < -4 V. This female SMB connector is provided only on instruments with Option UN7.

24. BER NO DATA Connector

The BER NO DATA connector outputs a signal that indicates the no data status. The no data status is reported when there has been no clock input for more than 3 seconds or there has been no data change for more than 200 bits. This signal is valid only when the signal of the BER MEAS END connector is high. No data status is detected when the signal is low. The damage levels are > +8 and < -4 V. This female SMB connector is provided only on instruments with Option UN7.

25. BER SYNC LOSS Connector

The BER SYNC LOSS connector outputs a signal that indicates the synchronization loss state. This signal is only valid when the signal of the BER MEAS END connector is high. Synchronization loss state is detected when the signal is low. The damage levels are $> +8$ and < -4 V. This female SMB connector is provided only on instruments with Option UN7.

26. BER DATA IN Connector

Use this connector to input the data streams for the bit-error-rate measurements. The rising (positive) or falling (negative) edge of the BER CLK IN signal (selected by the softkey or the GPIB command) is used to trigger the reading of the data. The damage levels are $> +8$ and < -4 V. This connector must be terminated with a TTL-compatible high impedance or 75Ω load. If you configure your instrument with Option 1EM, this input is changed from a BNC to an SMB connector. This female BNC connector is provided only on instruments with Option UN7.

27. BER CLK IN Connector

Use this connector to input the clock signal for the bit-error-rate measurements. The rising (positive) or falling (negative) edge of the signal (selected either by softkey or GPIB command) causes data on the BER DATA IN connector to be sampled. The damage levels are $> +8$ and < -4 V. This connector must be terminated with a TTL-compatible high impedance or 75Ω load. If your instrument is configured with Option 1EM, this input changes from a BNC to an SMB connector. This female BNC connector is provided only on instruments with Option UN7.

28. BER GATE IN Connector

Use this connector to input the clock gate signal for the bit-error-rate measurements. The clock signal to the BER CLK IN connector is valid only when the signal to this connector is a high or low, depending on your softkey selection or GPIB command. The damage levels are $> +8$ and < -4 V. This connector must be terminated with a TTL-compatible high impedance or 75Ω load. This connector can be enabled or disabled by a softkey or an GPIB command. This female BNC connector is provided only on instruments with Option UN7.

29. 321.4 MHz IN Connector

Use this connector to input a downconverted 321.4 MHz GSM signal for base transceiver station (BTS) loopback measurements. This female SMB connector is present only on instruments with Option 300.

4 Hardkey and Softkey Reference

This chapter describes each front panel hardkey and each softkey associated with the hardkey as well as the default value for each key. The chapter is organized alphabetically by front panel hardkey.

AM

Pressing the front panel **AM** key reveals a menu of softkeys. These softkeys are described in this section in alphabetical order.

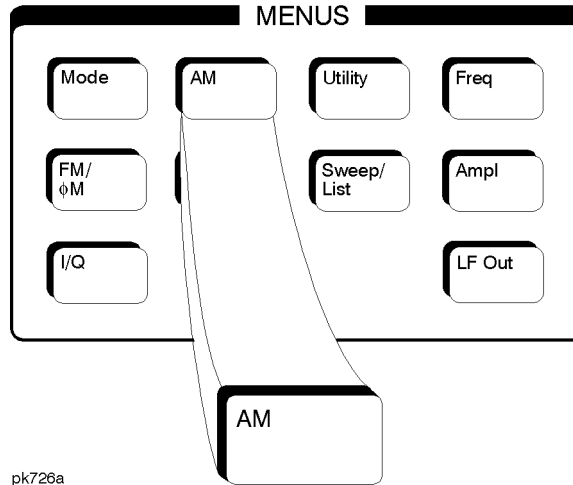

AM Depth

This softkey sets the amplitude modulation depth, in percent, for the **AM Path 1** and **AM Path 2** configurations. To change the value of the AM depth, press the softkey once. The current value for AM depth is displayed in the active entry area. To enter a new value, rotate the front panel knob until the desired value is displayed, use the up and down arrow keys, or enter the value using the numeric keypad and press the % terminator softkey. The range of values allowed is 0.1 to 100%. The minimum increment allowed is 0.1%. Notice that the new value of AM depth applies only to whichever AM path configuration (**AM Path 1** or **AM Path 2**) you have currently selected.

Default Value: 0.1%

Softkey Location: **AM > AM Depth**

Or: **AM > AM Waveform > Dual-Sine > AM Depth**

AM Depth Couple Off On

This softkey toggles the AM depth coupling on and off. AM depth coupling links the AM depth values of AM Path 1 and AM Path 2. When the values are coupled, any change you make to one AM depth value is applied to both AM depth values.

Default Value: Off

Softkey Location: **AM > AM Depth Couple Off On**

AM Off On

This softkey enables the amplitude modulation for whichever AM path configuration you have selected, **AM Path 1**, **AM Path 2**, or **AM Path WB**, in the case of a digitally equipped model. Notice, however, that although you can enable amplitude modulation with this softkey, the RF carrier is modulated by the enabled modulation only when you have also set **Mod On/Off** to **On**. Whenever amplitude modulation is enabled, the **AM** annunciator is turned on in the display.

There are two paths for AM modulation which can be simultaneously enabled as long as they use different sources (Int, Ext1, or Ext2). The modulation signals from both paths are summed internally for composite modulation.

Default Value: Off

Softkey Location: **AM** > **AM Off On**

AM Path 1 2 WB

NOTE

For the ESG-A and ESG-AP series, this softkey is **AM Path 1 2**. Wideband AM is not available on the ESG-A and ESG-AP series.

Use **AM Path 1** and **AM Path 2** to define two unique amplitude modulation configurations. For example, select **AM Path 1**. (**AM Path 1** is the default after a normal preset. If **AM Path 1** is not highlighted, press the **AM Path 1 2 WB** softkey until the selection toggles to **AM Path 1**.) Configure the modulation characteristics (such as depth, source, rate, and waveform) using the remaining softkeys in the AM menu. Then enable AM by setting **AM Off On** to **On**.

To configure a second amplitude modulation configuration, toggle to **AM Path 2**. Define the modulation characteristics for this second configuration and enable AM by setting **AM Off On** to **On**.

The RF carrier is available at the RF OUTPUT connector when you set **RF On/Off** to **On**. Set **Mod On/Off** to **On** to modulate the RF carrier with the modulations that you have enabled.

AM Path 1 and **AM Path 2** are summed internally for composite modulation. Either path can be switched to any one of the modulation sources: Int, Ext1, or Ext2. All modulation types can be simultaneously enabled, except FM with Φ M, AM with external burst source, and wideband AM with I/Q. AM, FM, and Φ M can sum simultaneous inputs from any two sources (Int, Ext1, and Ext2). Any given source (Int, Ext1, or Ext2) can only be routed to one activated modulation type.

AM

The wideband AM selection (**AM Path WB**) eliminates the bandwidth limitations of the ALC loop thereby increasing the bandwidth beyond that of the standard amplitude modulation. Typical rates for wideband AM are listed in the technical specifications document. When you select **AM Path WB** in the AM menu, you must apply your modulating signal to the I input. The sensitivity is 0.5 V = 100% AM depth. With **AM Path WB** selected, the modulated RF signal will be available at the RF OUTPUT connector when you turn on both **Mod On/Off** and **RF On/Off**.

Default Value: AM Path 1

Softkey Location: **AM > AM Path 1 2 WB**

AM Rate

Use this softkey to change the internal modulation frequency for the **AM Path 1** and **AM Path 2** configurations. To change the value, press the softkey once. The current value for AM rate is displayed in the active entry area. To enter a new value, rotate the front panel knob until the desired value is displayed, use the up and down arrow keys, or enter the value using the numeric keypad and press the **Hz** or **kHz** terminator softkey. The range of values allowed is 0.1 Hz to 10 kHz. (0.1 Hz to 50 kHz is the range allowed if sinewave is selected as the internal waveform.) The minimum increment allowed is 0.1 Hz. Notice that the new value of AM rate applies only to whichever AM configuration (**AM Path 1** or **AM Path 2**) you have currently selected.

Default Value: 400 Hz

Softkey Location: **AM > AM Rate**

AM Source

Pressing this softkey reveals a menu of choices for amplitude modulation sources. You can choose internally-generated amplitude modulation or select an externally-applied signal from either the **EXT 1 INPUT** or **EXT 2 INPUT** connectors. The internal modulation is always AC-coupled. For the externally-applied signals, you can choose between AC- and DC-coupled modulation. A 1.0 Vpk input is required for calibrated AM depth settings. The **EXT 1 LO/HI** and **EXT 2 LO/HI** display annunciators will turn on if the peak input voltage differs from 1.0 Vpk by more than 3%. (The LO/HI annunciators only function for AC-coupled external inputs.)

The internal and external 1 and 2 sources have multiple uses. You can use them for amplitude, frequency, and phase modulation. For burst modulation, you can only use the external 1 source and you must use the external 2 source for pulse modulation. However, any given source can only be routed to one enabled modulation at a time. If, for example, you were using the external 1 source in a frequency modulation configuration for **FM Path 1**, and then you configured **AM Path 2** to also use

the external 1 source, the signal generator would turn off **FM Path 1** and assign the external 1 source to your **AM Path 2** configuration. Notice that for these purposes the external 1 AC-coupled source is the same as the external 1 DC-coupled source and the external 2 AC-coupled source is the same as the external 2 DC-coupled source.

Default Value: Internal

Softkey Location: **AM > AM Source**

AM Start Rate

Use this softkey to change the starting internal modulation frequency for swept-sine amplitude modulation. To change the value, press the softkey once. The current value for the AM start rate is displayed in the active entry area. To enter a new value, rotate the front panel knob until the desired value is displayed, use the up and down arrow keys, or enter the value using the numeric keypad and press the **Hz** or **kHz** terminator softkey. The range of values allowed is 0.1 Hz to 50 kHz. The minimum increment allowed is 0.1 Hz.

This softkey is coupled to the **AM Rate** softkey in the initial AM Menu and the **AM Tone 1 Rate** softkey in the AM Dual-Sine Menu. Any value set for **AM Start Rate** is reflected in the **AM Rate** and **AM Tone 1 Rate** softkeys. Conversely, if you change the value for either the **AM Rate** softkey or the **AM Tone 1 Rate** softkey, the value for **AM Start Rate** is changed to match.

Default Value: 400.0 Hz

Softkey Location: **AM > AM Waveform > Swept-Sine > AM Start Rate**

AM Stop Rate

Use this softkey to change the ending internal modulation frequency for swept-sine amplitude modulation. To change the value, press the softkey once. The current value for the AM stop rate is displayed in the active entry area. To enter a new value, rotate the front panel knob until the desired value is displayed, use the up and down arrow keys, or enter the value using the numeric keypad and press the **Hz** or **kHz** terminator softkey. The range of values allowed is 0.1 Hz to 50 kHz. The minimum increment allowed is 0.1 Hz.

This softkey is coupled to the **AM Tone 2 Rate** softkey in the AM Dual-Sine Menu. Any value set for **AM Stop Rate** is reflected in the **AM Tone 2 Rate** softkey. Conversely, if you change the value for the **AM Tone 2 Rate** softkey, the value for **AM Stop Rate** is changed to match.

Default Value: 400.0 Hz

Softkey Location: **AM > AM Waveform > Swept-Sine > AM Stop Rate**

AM**AM Sweep Time**

Sets the sweep time for swept-sine amplitude modulation. The signal generator will vary the AM rate from the specified start rate to the stop rate in the time set with this softkey. Enter the desired sweep time using the up and down arrow keys, the front panel knob, or enter a value using the numeric keypad and press the **sec** or **msec** terminator softkey. The range of values allowed is 1 ms through 65.535 s. The minimum increment allowed is 1 ms.

Default Value: 100.0 msec

Softkey Location: **AM > AM Waveform > Swept-Sine > AM Sweep Time**

AM Sweep Trigger

Reveals a menu of choices for triggering swept-sine amplitude modulation. You can choose triggering that occurs immediately, triggering that is supplied by the GPIB, triggering on either the positive or negative edge of a signal supplied to the TRIGGER IN connector, or triggering by the front panel Trigger key.

Default Value: Immediate

Softkey Location: **AM > AM Waveform > Swept-Sine > AM Sweep Trigger**

AM Tone 1 Rate

Sets the internal modulation frequency for the AM tone 1. Enter the desired rate using the up and down arrow keys, the front panel knob, or enter a value using the numeric keypad and press the **kHz** or **Hz** terminator softkey. The range of values allowed is 0.1 Hz through 50 kHz. The minimum increment allowed is 0.1 Hz.

This softkey is coupled to the **AM Rate** softkey in the initial AM Menu and the **AM Start Rate** softkey in the AM Swept-Sine Menu. Any value set for **AM Tone 1 Rate** is reflected in the **AM Rate** and **AM Start Rate** softkeys. Conversely, if you change the value for either the **AM Rate** softkey or the **AM Start Rate** softkey, the value for **AM Tone 1 Rate** is changed to match.

Default Value: 400.0 Hz

Softkey Location: **AM > AM Waveform > Dual-Sine > AM Tone 1 Rate**

AM Tone 2 Ampl Percent Of Peak

For example, if the Tone 2 amplitude is 0%, then there would be no amplitude for Tone 2; all of the signal strength would be present in Tone 1. If **AM Tone 2 Ampl Percent Of Peak** is set to 50%, then Tone 2 and Tone 1 would have equal amplitudes, or half of the amplitude of both tones combined.

Default Value: 50.0%

Softkey Location: **AM** > **AM Waveform** > **Dual-Sine** >
AM Tone 2 Ampl Percent Of Peak

AM Tone 2 Rate

Press this softkey to set the internal modulation frequency for the AM tone 2. Enter the desired rate using the up and down arrow keys, the front panel knob, or enter a value using the numeric keypad and press the **kHz** or **Hz** terminator softkey. The range of values allowed is 0.1 Hz through 50 kHz. The minimum increment allowed is 0.1 Hz.

This softkey is coupled to the **AM Rate** softkey in the initial AM Menu and the **AM Stop Rate** softkey in the AM Swept-Sine Menu. Any value set for **AM Tone 2 Rate** is reflected in the **AM Rate** and **AM Stop Rate** softkeys. Conversely, if you change the value for either the **AM Rate** softkey or the **AM Stop Rate** softkey, the value for **AM Tone 2 Rate** is changed to match.

Default Value: 400.0 Hz

Softkey Location: **AM** > **AM Waveform** > **Dual-Sine** > **AM Tone 2 Rate**

AM Waveform

Pressing this softkey reveals a menu of AM waveform choices for your **AM Path 1** and **AM Path 2** configurations. Select from sine, triangle, square, ramp, noise, dual-sine, and swept-sine waveforms. Notice that your waveform selection applies only to whichever AM path configuration you have currently selected.

Default Value: Sine

Softkey Location: **AM** > **AM Waveform**

Bus

This softkey is one of the choices in the AM Sweep Trigger menu. With **Bus** selected, you use the GPIB to trigger single sweeps of swept-sine amplitude modulation.

Softkey Location: **AM** > **AM Waveform** > **Swept-Sine** > **AM Sweep Trigger** > **Bus**

AM

Dual-Sine

Reveals a menu of choices for setting the dual-sine amplitude modulation parameters. In this menu you can set the AM rates for two separate tones. In addition, you can set the AM depth for **AM Path 1** and **AM Path 2** and also set a ratio of the tone 2 AM depth to the tone 1 AM depth.

Softkey Location: **AM > AM Waveform > Dual-Sine**

Ext

Being one of the choices in the AM Sweep Trigger menu, choosing **Ext** allows you to trigger swept-sine amplitude modulation using the signal applied to the TRIGGER IN rear panel connector. Set the polarity of the trigger signal using the **Trigger In Polarity Neg Pos** softkey.

Softkey Location: **AM > AM Waveform > Swept-Sine > AM Sweep Trigger > Ext**

Ext 1 AC-Coupled

Inputs an external, AC-coupled, amplitude modulation signal to the EXT 1 INPUT connector. The modulation signal is tested for voltage and a display annunciator will report a high or low condition if the voltage is $> \pm 3\%$ of 1 Vpk.

The external 1 input has multiple uses but can be used for only one modulation at a time. If, for example, you were using the external 1 input in a frequency modulation configuration for **FM Path 1**, and then you configured **AM Path 2** to also use the external 1 input, the signal generator would turn off **FM Path 1** and assign the external 1 input to your **AM Path 2** configuration. (For the purpose of this discussion, the external 1 AC-coupled input is the same as the external 1 DC-coupled input.)

Softkey Location: **AM > AM Source > Ext 1 AC-Coupled**

Ext 1 DC-Coupled

Inputs an external, DC-coupled, amplitude modulation signal to the EXT 1 INPUT connector.

The external 1 input has multiple uses but can be used for only one modulation at a time. If, for example, you were using the external 1 input in a frequency modulation configuration for **FM Path 1**, and then you configured **AM Path 2** to also use the external 1 input, the signal generator would turn off **FM Path 1** and assign the external 1 input to your **AM Path 2** configuration. (For the purpose of this discussion, the external 1 AC-coupled input is the same as the external 1 DC-coupled input.)

Softkey Location: **AM > AM Source > Ext 1 DC-Coupled**

Ext 2 AC-Coupled

This softkey lets you input an external, AC-coupled, amplitude modulation signal to the EXT 2 INPUT connector. The modulation signal is tested for voltage and a display annunciator will report a high or low condition if the voltage is $> \pm 3\%$ of 1 Vpk.

The external 2 input has multiple uses, but can be used for only one modulation at a time. If, for example, you were using the external 2 input in a frequency modulation configuration for **FM Path 1**, and then you configured **AM Path 2** to also use the external 2 input, the signal generator would turn off **FM Path 1** and assign the external 2 input to your **AM Path 2** configuration. (For the purpose of this discussion, the external 2 AC-coupled input is the same as the external 2 DC-coupled input.)

Softkey Location: **AM > AM Source > Ext 2 AC-Coupled**

Ext 2 DC-Coupled

This softkey lets you input an external, DC-coupled, amplitude modulation signal to the EXT 2 INPUT connector.

The external 2 input has multiple uses but can be used for only one modulation at a time. If, for example, you were using the external 2 input in a frequency modulation configuration for **FM Path 1**, and then you configured **AM Path 2** to also use the external 2 input, the signal generator would turn off **FM Path 1** and assign the external 2 input to your **AM Path 2** configuration. (For the purpose of this discussion, the external 2 AC-coupled input is the same as the external 2 DC-coupled input.)

Softkey Location: **AM > AM Source > Ext 2 DC-Coupled**

Immediate

This softkey is one of the choices in the AM Sweep Trigger menu. Choosing **Immediate** immediately triggers swept-sine amplitude modulation in a continuous mode. To stop the sweep, choose a different trigger such as **Ext**, or set the waveform to something other than **Swept-Sine**.

Softkey Location: **AM > AM Waveform > Swept-Sine > AM Sweep Trigger > Immediate**

AM**Internal**

This softkey lets you connect an internally-generated, calibrated signal to the AM modulator. The default state of the internal waveform generator is a 400 Hz sinewave with 0.1% depth.

The internal source has multiple uses but can be used for only one modulation at a time. If, for example, you were using the internal source in a frequency modulation configuration for **FM Path 1**, and then you configured **AM Path 2** to also use the internal source, the signal generator would turn off **FM Path 1** and assign the internal source to your **AM Path 2** configuration.

Softkey Location: **AM > AM Source > Internal**

Noise

This softkey lets you specify noise as the amplitude modulation waveform for the **AM Path 1** and **AM Path 2** configurations. Notice that the selected waveform applies only to whichever AM path configuration you have currently selected.

Softkey Location: **AM > AM Waveform > Noise**

Ramp

This softkey lets you specify ramp as the amplitude modulation waveform for the **AM Path 1** and **AM Path 2** configurations. Notice that the selected waveform applies only to whichever AM path configuration you have currently selected.

Softkey Location: **AM > AM Waveform > Ramp**

Sine

This softkey lets you specify sine as the amplitude modulation waveform for the **AM Path 1** and **AM Path 2** configurations. Notice that the selected waveform applies only to whichever AM path configuration you have currently selected.

Softkey Location: **AM > AM Waveform > Sine**

Square

This softkey lets you specify square as the amplitude modulation waveform for the **AM Path 1** and **AM Path 2** configurations. Notice that the selected waveform applies only to whichever AM path configuration you have currently selected.

Softkey Location: **AM > AM Waveform > Square**

Swept-Sine

Pressing this softkey reveals a menu of choices for setting the swept-sine amplitude modulation parameters. In this menu you can set the start and stop AM rate and the sweep time. You can set the signal generator to a single, externally-triggered sweep on either a negative or positive TTL level or you can choose continuous sweep, triggered immediately. In this menu you can also select either a positive or negative polarity for the TRIGGER OUT signal.

Softkey Location: **AM > AM Waveform > Swept-Sine**

Triangle

This softkey lets you specify triangle as the amplitude modulation waveform for the **AM Path 1** and **AM Path 2** configurations. Notice that the selected waveform applies only to whichever AM path configuration you have currently selected.

Softkey Location: **AM > AM Waveform > Triangle**

Trigger In Polarity Neg Pos

Press this softkey to toggle between a negative TTL level trigger (0 V) and a positive TTL level trigger (+5 V) for externally triggering swept-sine amplitude modulation.

This softkey is coupled to the **Trigger In Polarity Neg Pos** softkey for swept-sine FM, Φ M, and LF Out, and to the **Ext Neg** and **Ext Pos** sweep trigger selections in the Sweep/List Menu. If you set the **Trigger In Polarity Neg Pos** softkey in the AM Swept-Sine Menu to **Neg**, the **Trigger In Polarity Neg Pos** softkey is also set to **Neg** for swept-sine FM, Φ M, and LF Out. In addition, if the step or list sweep is set to externally trigger, the selection will automatically be set to **Ext Neg**. The same softkeys will toggle to **Pos** or to **Ext Pos** if you select **Pos** in the Swept-Sine AM Menu.

Conversely, if the **Trigger In Slope Neg Pos** softkey is toggled in the swept-sine FM, Φ M, or LF Out menus, it will cause the swept-sine AM softkey to toggle also. This is also true for the **Ext Neg** and **Ext Pos** step or list sweep trigger selections.

Default Value: Pos

Softkey Location: **AM > AM Waveform > Swept-Sine >**

Trigger In Polarity Neg Pos

Trigger Key

This softkey is one of the choices in the AM Sweep Trigger menu. With **Trigger Key** selected, when you press the **Trigger** front panel key you immediately trigger a single sweep of swept-sine amplitude modulation.

The **Trigger** key has autorepeat capability. Hold it down and you will repeatedly trigger sweeps until you release the key.

Softkey Location: **AM > AM Waveform > Swept-Sine > AM Sweep Trigger > Trigger Key**

Trigger Out Polarity Neg Pos

This softkey toggles the polarity of the TTL signal that is output at the rear panel TRIGGER OUT connector. When **Trigger Out Polarity Neg Pos** is set to **Pos**, the output signal is asserted high (+5 V) at the start of the swept-sine amplitude modulation sweep and low (0 V) when the sweep is concluded. Setting **Trigger Out Polarity Neg Pos** to **Neg** reverses the polarity, where a high is 0 V and a low is +5 V.

This softkey is coupled to the **Trigger Out Polarity Neg Pos** softkey in the swept-sine FM, Φ M, and LF Out menus and the sweep/list menu. When the polarity is toggled for this softkey in any one of these menus, it affects all locations of the softkey.

Default Value: Pos

Softkey Location: **AM > AM Waveform > Swept-Sine > Trigger Out Polarity Neg Pos**

Ampl

Pressing the front panel **Ampl** key reveals a menu of softkeys. These softkeys are described in this section in alphabetical order.

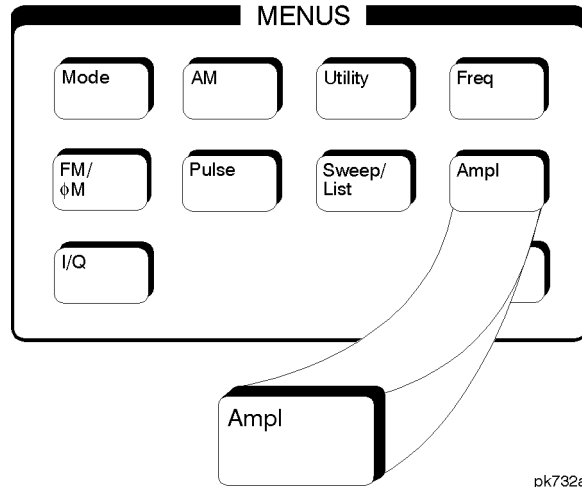

ALC BW Normal Narrow

Press this softkey to toggle between ALC normal and narrow bandwidth modes. The bandwidth is automatically set to narrow when external I/Q modulation is turned on, and automatically set to normal when I/Q modulation is turned off. Setting **ALC BW Normal Narrow** to **Narrow** limits the bandwidth to 100 Hz which can improve EVM. Narrow bandwidth mode may, however, also slow the settling time for frequency changes to as much as 40 ms. This softkey is inactive when internal I/Q modulation is turned on.

Default Value: Normal

Softkey Location: **Ampl** > **ALC BW Normal Narrow**

ALC Off On

This softkey toggles the automatic leveling control (ALC) circuit off and on.

The ALC is normally on. The RF output power of the signal generator is constantly monitored and controlled by the ALC circuit. Its purpose is to hold output power at its desired level in spite of drift due to temperature and time.

There are some modulation conditions which the ALC circuit cannot handle properly which lead to output level errors. In these conditions, better power level accuracy can be obtained by turning the ALC off and using power search. (Refer to the [Power Search Manual Auto](#) softkey documented in this section for more information about power search.) ALC Off is useful with pulse modulation with a pulse width narrower than 2 μ s and with certain external I/Q modulation.

Pulse modulation is accomplished using a modulator which precedes the ALC detector. The ALC must, therefore, measure a pulsed signal, and it is able to do this if the pulse width exceeds 2 μ s. For narrower pulses, set the ALC softkey to Off.

With external I/Q modulation, the ALC loop acts to hold the signal generator's average output power constant, in spite of variations in the I/Q input power ($I^2 + Q^2$). Rapid variations of ($I^2 + Q^2$) propagate to the output, while slow variations are removed by the ALC loop, with a high-pass corner of 1 kHz. If you do not want this high-pass filtering, set the ALC Off On softkey to Off. With ALC off, the I/Q modulation will be DC-coupled. Using power search, power level accuracy is preserved if $\sqrt{I^2 + Q^2} = 0.5 V_{\text{RMS}}$.

When ALC is off, the ALC OFF display annunciator will turn on.

NOTE

An alternative to setting the ALC off is to set the ALC bandwidth to narrow. See the [ALC BW Normal Narrow](#) softkey in the this section.

Default Value: On

Softkey Location: Ampl > ALC Off On

Alternate Amplitude (Option UNA Only)

Pressing this softkey reveals a menu used to configure the alternate amplitude function. The menu includes softkeys for configuring the alternate amplitude state (on or off), delta, triggering (internal, external, or manual), and subsequently, manual triggering between the main and alternate amplitudes. This softkey and its subfunctions are only available with the Alternate Timeslot Power Level Control option.

Softkey Location: Ampl > Alternate Amplitude

Alt Ampl Delta (Option UNA Only)

Press this softkey to set the delta value for the alternate amplitude function. The actual alternate amplitude is equal to the delta value plus the main RF output amplitude plus the amplitude offset value minus the amplitude reference value.

Default Value: 0.00 dB

Softkey Location: **Ampl > Alternate Amplitude > Alt Ampl Delta**

Alt Ampl Off On (Option UNA Only)

Toggles the operating state of the alternate amplitude function between off and on. The alternate amplitude mode must be turned on in order to switch the RF output power between main and alternate amplitudes.

Default Value: Off

Softkey Location: **Ampl > Alternate Amplitude > Alt Ampl Off On**

Alt Ampl Trigger (Option UNA Only)

Reveals a menu of choices for the alternate amplitude trigger source. These choices include Int (internal from the baseband generator), Ext (external source provided at the rear panel TRIGGER IN connector), and Manual (softkey-driven) triggering.

Internal triggering is mainly used during framed-data generation. Each timeslot is allowed to output power with a user-selected main or alternate amplitude. For instruments without baseband generators, the Int softkey will be nonfunctional.

For instruments containing baseband generators, internal triggering is automatically selected during framed data transmission with at least one activated timeslot with alternate amplitude, or during non-framed external data generation.

In cases regarding non-framed external data generation, an external trigger to the ALT PWR IN rear panel connector is required. This external trigger input is routed to the data generator for processing.

Default Value: Manual

Softkey Location: **Ampl > Alternate Amplitude > Alt Ampl Trigger**

Ampl Offset

Sets a value for amplitude offset. An amplitude offset changes the value shown in the amplitude area of the display but does not affect the output power. For example, if the current output power is 0 dBm and you enter an amplitude offset of -3 dBm, the output power will remain at 0 dBm but the display will show an amplitude of -3 dBm. This feature lets you simulate the power level at a test point beyond the RF OUTPUT connector.

An amplitude offset can be entered at any time during normal operation and also when you are operating in amplitude reference mode. To enter an offset, press **Ampl Offset** and enter the desired offset value using the up and down arrow keys, the front panel knob, or enter a value using the numeric keypad and press the **dB** terminator softkey. When a non-zero offset has been entered, the **OFFSET** indicator is turned on in the amplitude area of the display.

Default Value: 0.00 dB

Softkey Location: **Ampl** > **Ampl Offset**

Ampl Ref Set

This softkey sets the current output power as an amplitude reference value. It also causes the **Ampl Ref Off On** softkey to toggle to the **On** position, turning on amplitude reference mode. All amplitude parameters are then set as relative to the reference value.

Default Value: 0.0 dBm

Softkey Location: **Ampl** > **Ampl Ref Set**

Ampl Ref Off On

This softkey toggles the amplitude reference mode on and off. When amplitude reference mode is turned on, the amplitude value displayed is equal to the current hardware output power minus the reference value set by the **Ampl Ref Set** softkey. (The **Ampl Ref Set** softkey sets the reference value equal to the current output power. If you have not yet set the reference value, the normal preset value for amplitude reference is 0 dBm.) The **REF** indicator is turned on in the amplitude area of the display. All amplitude parameters will now be set as relative to the reference value.

Amplitude offsets can be used with amplitude reference mode. In this situation, the display will show the amplitude calculated as the current hardware output power minus the reference value plus the amplitude offset.

Amplitude reference mode only changes the display; it does not change the RF output power. For example, if you set your RF output power to -20 dBm, set your reference value, and then turn amplitude reference mode on, your display shows your amplitude as 0 dB but your output power remains at -20 dBm.

Default Value: Off

Softkey Location: **Ampl > Ampl Ref Off On**

Atten Hold Off On

This softkey toggles the attenuator hold function on and off. Turn attenuator hold on to freeze the attenuator at its current setting. The **ATTN HOLD** display annunciator will turn on. Use this function at any time you want to guarantee that there will be no power discontinuity normally associated with the attenuator switching during power adjustments. (When the attenuator is held, only a frequency change will change the attenuator setting. There will be no attenuator switching during power adjustments.) With attenuator hold on, the maximum power adjustment range will vary. However, you will have at least $+4$ dB and at least -13 dB range.

Default Value: Off

Softkey Location: **Ampl > Atten Hold Off On**

Do Power Search

Press this softkey to execute the power search routine one time. Power search is an internal calibration routine used to achieve calibrated output power when the ALC is off. You can execute a power search at any time by pressing this softkey. If you are using external I/Q modulation, the power search routine assumes that the I/Q input level is $\sqrt{I^2 + Q^2} = 0.5 V_{\text{rms}}$.

Actual output amplitude will scale directly with $\sqrt{I^2 + Q^2}$.

The **ALC Off On** softkey must be set to **Off** in order to execute the power search routine.

Softkey Location: **Ampl > ALC Off On > Do Power Search**

Manual Trigger Main Delta (Option UNA Only)

Press this softkey to toggle the RF output power between main and alternate (delta). When Main is highlighted, the main power is present at the RF output and when Delta is highlighted, the alternate power is present at the RF output.

Default Value: Main

Softkey Location: **Ampl > Alternate Amplitude > Manual Trigger Main Delta**

Power Search

This softkey accesses a menu from which you can change power search parameters.

Softkey Location: Ampl > ALC Off On > Power Search

Power Search Manual Auto

This softkey toggles between the auto and manual modes of power search mode. Power search is an internal calibration routine used to achieve calibrated output power when the ALC is off. When you set **Power Search Manual Auto** to **Auto**, power search will execute automatically with each change to the RF frequency or power, and also with each change to the AM, burst, pulse, or I/Q modulation state. If you are using external I/Q modulation, the power search routine assumes that the I/Q input level is $\sqrt{I^2 + Q^2} = 0.5 V_{\text{rms}}$.

Actual output amplitude will scale directly with $\sqrt{I^2 + Q^2}$.

When you set **Power Search Manual Auto** to **Manual**, the power search routine is not run until the **Do Power Search** softkey is pressed.

The **ALC Off On** softkey must be set to **Off** in order to engage either power search mode.

Default Value: Manual

Softkey Location: Ampl > ALC Off On > Power Search Manual Auto

Power Search Reference Fixed Modulated

This softkey toggles between fixed and modulated modes of power search. Power search is an internal calibration routine used to achieve calibrated output power when the ALC is off. When you set **Power Search Reference Fixed Modulated** to **Fixed**, power search uses a 0.5 Volt reference. When you set **Power Search Reference Fixed Modulated** to **Modulated**, the current I/Q modulation remains active and the reference is the RMS value of the current I/Q modulation.

The **ALC Off On** softkey must be set to **Off** in order to engage either power search reference.

Default Value: Fixed

Softkey Location: Ampl > ALC Off On > Power Search >
Power Search Reference Fixed Modulated.

Amplitude

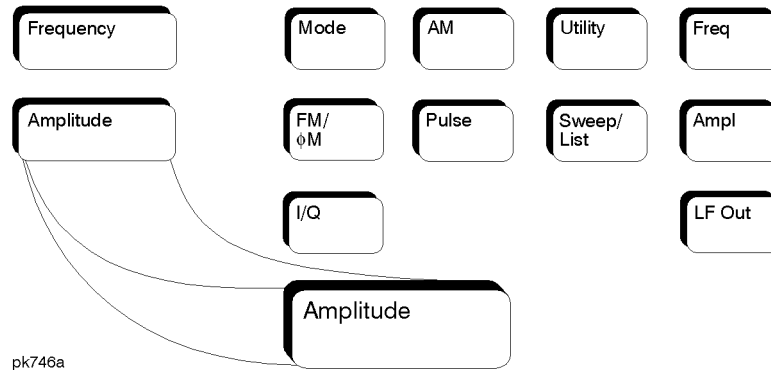

Press this front panel hardkey to change the RF output power. Amplitude becomes the active function and the current value is shown in the active entry area of the display. To enter a new value for amplitude, rotate the front panel knob until the desired value is displayed, use the up and down arrow keys, or enter the value using the numeric keypad and press the dBm, dBuV, dBuVemf, mV, uV, mVemf, or uVemf terminator softkey. The output power range allowed depends on your instrument model. Refer to the technical specifications document.

The current RF output power level is always shown in the amplitude area of the display except under the following conditions:

- amplitude reference mode is turned on
- an offset is applied
- a step or list amplitude sweep is in process
- the RF Off On front panel key is off

The amplitude area of the display is blanked whenever an amplitude sweep is selected.

Default Value: -135 dBm

Arrow Keys

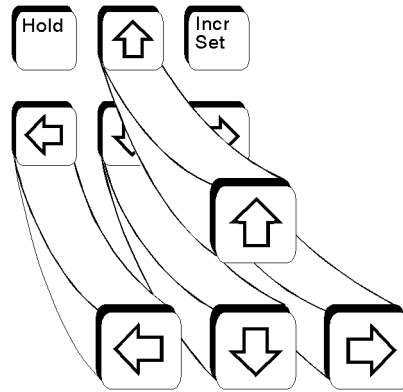

pk750a

Use the up and down arrow keys to increase and decrease the value of a numeric parameter by the increment value. For example, when frequency is the active function, if the current frequency setting is 1 MHz and the increment value set is 1 kHz, pressing the up and down arrow keys will increase and decrease the 1 MHz frequency in 1 kHz steps.

In addition, you can use the up and down arrow keys to scroll through displayed lists to select items.



The left and right arrow keys choose the highlighted digit in the active entry area, which is modified by the up and down arrow keys. When a digit is highlighted it overrides the increment value used with the up and down arrow keys. This override remains in effect until the **Incr Set** key is pressed, an instrument preset occurs, or power is cycled. For example, if frequency is the active parameter and you press the right arrow key until the 1 kHz position is highlighted, the up and down arrow keys will increase and decrease the frequency in 1 kHz increments no matter where the **Incr Set** key has been set.

The arrow keys have autorepeat capability. Hold a key down and its function is continuously executed until you release it.

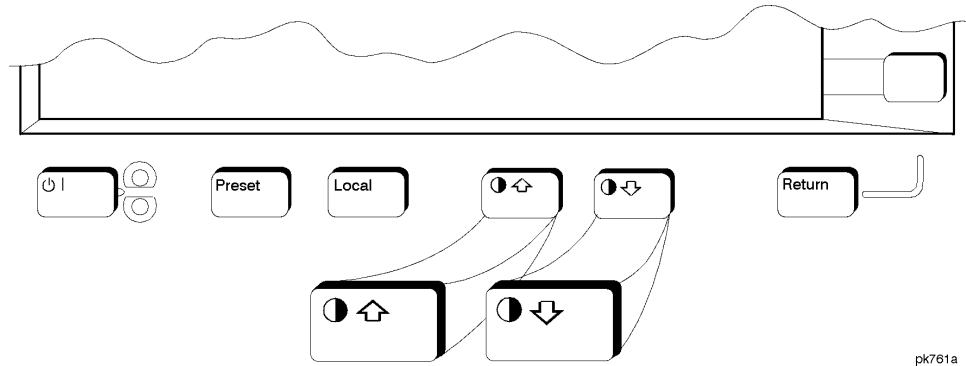
Display Contrast Keys



pk761a

You can adjust the contrast of the display by pressing the decrease contrast key  or the increase contrast key .

Pressing the decrease contrast key and holding it down causes the display background to gradually darken in comparison to the text on the display. The minimum contrast setting is not a completely black display. Some contrast between the background and the text will still be visible.

Pressing the increase contrast key and holding it down causes the display background to gradually brighten in comparison to the text on the display. If the background does not appear to change, it is probably set to the maximum contrast.

Display contrast is a persistent state; it is not affected by an instrument preset or by a power cycle.

FM

Pressing the front panel **FM/ΦM** key reveals a menu of softkeys. The softkeys for FM are described in this section in alphabetical order. For a description of the ΦM softkeys, refer to the “[Phase Modulation](#)” section in this chapter.

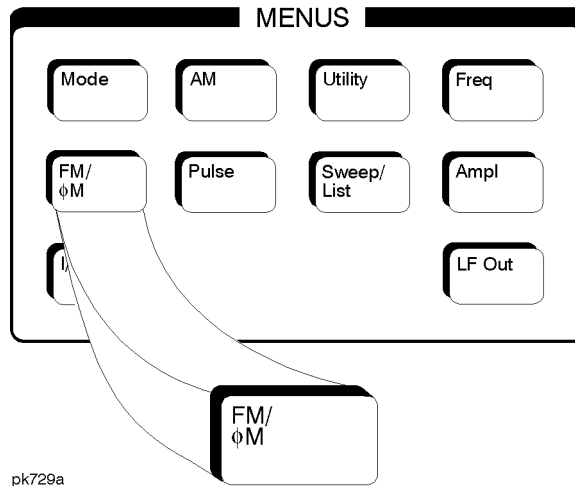

Bus

This softkey is one of the choices in the FM Sweep Trigger menu. With **Bus** selected, you use the GPIB to trigger single sweeps of swept-sine frequency modulation.

Softkey Location: **FM/ΦM** > **FM Waveform** > **Swept-Sine** > **FM Sweep Trigger** > **Bus**

DCFM/DCΦM Cal

Pressing this softkey initiates a DCFM calibration. This calibration eliminates the offset in DC FM so that the carrier frequency remains the same with no modulation applied. External, DC-coupled FM must be active when this calibration is executed.

Softkey Location: **FM/ΦM** > **DCFM/DCΦM Cal**

Dual-Sine

Pressing this softkey reveals a menu of choices for setting the dual-sine frequency modulation parameters. In this menu you can set the FM rates for two separate tones. In addition, you can set the FM deviation for **FM Path 1** and **FM Path 2** and also set a ratio of the tone 2 FM deviation to the tone 1 FM deviation.

Softkey Location: **FM/ΦM** > **FM Waveform** > **Dual-Sine**

Ext

This softkey is one of the choices in the FM Sweep Trigger menu. Choosing **Ext** allows you to trigger swept-sine frequency modulation using a signal applied to the TRIGGER IN rear panel connector. Set the polarity of the trigger signal using the **Trigger In Polarity Neg Pos** softkey.

Softkey Location: **FM/ΦM > FM Waveform > Swept-Sine > FM Sweep Trigger > Ext**

Ext 1 AC-Coupled

This softkey lets you input an external, AC-coupled, frequency modulation signal to the EXT 1 INPUT connector. The modulation signal is tested for voltage and a display annunciator will report a high or low condition if the voltage is $> \pm 3\%$ of 1 Vpk.

The external 1 input has multiple uses but can be used for only one modulation at a time. If, for example, you were using the external 1 input in an amplitude modulation configuration for **AM Path 1**, and then you configured **FM Path 2** to also use the external 1 input, the signal generator would turn off **AM Path 1** and assign the external 1 input to your **FM Path 2** configuration. For the purposes of this discussion, the external 1 AC-coupled input is the same as the external 1 DC-coupled source.

Softkey Location: **FM/ΦM > FM Source > Ext 1 AC-Coupled**

Ext 1 DC-Coupled

This softkey lets you input an external, DC-coupled, frequency modulation signal to the EXT 1 INPUT connector.

The external 1 input has multiple uses but can be used for only one modulation at a time. If, for example, you were using the external 1 input in an amplitude modulation configuration for **AM Path 1**, and then you configured **FM Path 2** to also use the external 1 input, the signal generator would turn off **AM Path 1** and assign the external 1 input to your **FM Path 2** configuration. For the purposes of this discussion, the external 1 AC-coupled input is the same as the external 1 DC-coupled source.

Softkey Location: **FM/ΦM > FM Source > Ext 1 DC-Coupled**

Ext 2 AC-Coupled

This softkey lets you input an external, AC-coupled, frequency modulation signal to the EXT 2 INPUT connector. The modulation signal is tested for voltage and a display annunciator will report a high or low condition if the voltage is $> \pm 3\%$ of 1 Vpk.

The external 2 input has multiple uses but can be used for only one modulation at a time. If, for example, you were using the external 2 input in an amplitude modulation configuration for AM Path 1, and then you configured FM Path 2 to also use the external 2 input, the signal generator would turn off AM Path 1 and assign the external 2 input to your FM Path 2 configuration. For the purposes of this discussion, the external 2 AC-coupled input is the same as the external 2 DC-coupled source.

Softkey Location: FM/ Φ M > FM Source > Ext 2 AC-Coupled

Ext 2 DC-Coupled

This softkey lets you input an external, DC-coupled, frequency modulation signal to the EXT 2 INPUT connector.

The external 2 input has multiple uses but can be used for only one modulation at a time. If, for example, you were using the external 2 input in an amplitude modulation configuration for AM Path 1, and then you configured FM Path 2 to also use the external 2 input, the signal generator would turn off AM Path 1 and assign the external 2 input to your FM Path 2 configuration. For the purposes of this discussion, the external 2 AC-coupled input is the same as the external 2C-coupled source.

Softkey Location: FM/ Φ M > FM Source > Ext 2 DC-Coupled

FM Φ M

This softkey toggles between the menus for FM, normal Φ M, and wideband Φ M. Refer to the “[Phase Modulation](#)” section for a discussion of the differences between normal Φ M, and wideband Φ M.

Default Value: FM

Softkey Location: FM/ Φ M hardkey > FM Φ M softkey

FM Dev

Use this softkey to set the frequency modulation deviation for the **FM Path 1** and **FM Path 2** configurations. To change the value of the FM deviation, press the softkey once. The current value for FM deviation is displayed in the active entry area. To enter a new value, rotate the front panel knob until the desired value is displayed, use the up and down arrow keys, or enter the value using the numeric keypad and press the **Hz**, **kHz**, **MHz**, or **GHz** terminator softkey. The range of values allowed depends on the carrier frequency. The maximum peak deviation for a frequency is calculated by multiplying N times 10 MHz. (Table 4-1 lists the values for N and the resulting maximum peak deviations.)

Table 4-1 Maximum Deviation Values for Frequency Modulation

Carrier Frequency	N	Maximum Peak Deviation
250 kHz to ≤ 249.999 MHz	1	10 MHz
> 249.999 MHz to ≤ 500 MHz	0.5	5 MHz
> 500 MHz to ≤ 1 GHz	1	10 MHz
> 1 GHz to ≤ 2 GHz	2	20 MHz
> 2 GHz to 4 GHz	4	40 MHz

For example, if you choose a carrier frequency of 400 MHz, multiply 0.5 by 10 MHz resulting in a 5 MHz maximum peak deviation.

Notice that the new value of FM deviation applies only to whichever FM path configuration you have currently selected. Also, whenever **FM Path 1** is used with **FM Path 2**, the deviation for **FM Path 1** must be greater than or equal to the deviation for **FM Path 2**.

Default Value: 1 kHz

Softkey Location: **FM/ΦM > FM Dev**

Or: **FM/ΦM > FM Waveform > Dual-Sine > FM Dev**

FM Dev Couple Off On

Toggles the FM deviation coupling on and off. Turning on FM deviation coupling links the FM deviation values of **FM Path 1** and **FM Path 2**. When the values are coupled, any change you make to one FM deviation value is applied to both FM deviation values.

Default Value: Off

Softkey Location: **FM/ΦM > FM Dev Couple Off On**

FM Off On

Toggles the frequency modulation on or off for whichever FM path configuration (**FM Path 1** or **FM Path 2**) you have selected. Notice, however that although you can turn on frequency modulation with this softkey, the RF carrier is modulated by the enabled modulation only when you have also set **Mod On/Off** to **On**. Whenever frequency modulation is enabled, the **FM** annunciator is turned on in the display.

There are two paths for FM modulation which can be simultaneously enabled as long as they use different sources (Int, Ext1, or Ext2). **FM Path 2** is limited to a maximum rate of 1 MHz. **FM Path 2** must be set to a deviation less than or equal to **FM Path 1**. The modulation signals from both paths are summed internally for composite modulation.

Default Value: Off

Softkey Location: **FM/ΦM** > **FM Off On**

FM Path 1 2

Use **FM Path 1** and **FM Path 2** to define two unique frequency modulation configurations. For example, select **FM Path 1**. (**FM Path 1** is the default after a normal preset. If **FM Path 1** is not highlighted, press the softkey until the selection toggles to **FM Path 1**.) Configure the modulation characteristics (such as deviation, source, rate, and waveform) using the remaining softkeys in the FM menu. Then enable FM by setting **FM Off On** to **On**.

To configure a second frequency modulation configuration, toggle to **FM Path 2**. Define the modulation characteristics for this second configuration and enable FM by setting **FM Off On** to **On**.

The RF carrier is available at the RF OUTPUT connector when you set **RF On/Off** to **On**. Set **Mod On/Off** to **On** to modulate the RF carrier with the modulations that you have enabled.

FM Path 1 and **FM Path 2** are summed internally for composite modulation. Either path can be switched to any one of the modulation sources: Int, Ext1, or Ext2. All modulation types can be simultaneously enabled, except FM with ΦM , AM with external burst source, and wideband AM with I/Q. AM, FM, and ΦM can sum simultaneous inputs from any two sources (Int, Ext1, and Ext2). Any given source (Int, Ext1, or Ext2) can only be routed to one activated modulation type.

Default Value: FM Path 1

Softkey Location: **FM/ΦM** > **FM Path 1 2**

FM Rate

Use this softkey to change the internal modulation frequency for the **FM Path 1** and **FM Path 2** configurations. To change the value, press the softkey once. The current value for FM rate is displayed in the active entry area. To enter a new value, rotate the front panel knob until the desired value is displayed, use the up and down arrow keys, or enter the value using the numeric keypad and press the **Hz** or **kHz** terminator softkey. The range of values allowed is 0.1 Hz to 10 kHz. (0.1 Hz to 50 kHz is the range allowed if sinewave is selected as the internal waveform.) The minimum increment allowed is 0.1 Hz. Notice that the new value of FM rate applies only to whichever FM path configuration you have currently selected.

Default Value: 400 Hz

Softkey Location: **FM/ΦM** > **FM Rate**

FM Source

Pressing this softkey reveals a menu of choices for frequency modulation sources. You can choose internally-generated frequency modulation or select an externally-applied signal from either the **EXT 1 INPUT** or **EXT 2 INPUT** connectors. The internal modulation is always AC-coupled. For the externally-applied signals, you can choose between AC- and DC-coupled modulation. A 1.0 Vpk input is required for calibrated FM deviation settings. The **EXT 1 LO/HI** and **EXT 2 LO/HI** display annunciators will turn on if the peak input voltage differs from 1.0 Vpk by more than 3%. (The LO/HI annunciators only function for AC-coupled external inputs.)

The internal and external 1 and 2 sources have multiple uses. You can use them for amplitude, frequency, and phase modulation. For burst modulation, you can only use the external 1 source. You must use the external 2 source for pulse modulation. However, any given source can only be routed to one enabled modulation at a time. If, for example, you were using the external 1 source in a frequency modulation configuration for **FM Path 1**, and then you configured **AM Path 2** to also use the external 1 source, the signal generator would turn off **FM Path 1** and assign the external 1 source to your **AM Path 2** configuration. Notice that for these purposes the external 1 AC-coupled source is the same as the external 1 DC-coupled source and the external 2 AC-coupled source is the same as the external 2 DC-coupled source.

Default Value: Internal

Softkey Location: **FM/ΦM** > **FM Source**

FM Start Rate

Changes the starting internal modulation frequency for swept-sine frequency modulation. To change the value, press the softkey once. The current value for the FM start rate is displayed in the active entry area. To enter a new value, rotate the front panel knob until the desired value is displayed, use the up and down arrow keys, or enter the value using the numeric keypad and press the Hz or kHz terminator softkey. The range of values allowed is 0.1 Hz to 50 kHz. The minimum increment allowed is 0.1 Hz.

This softkey is coupled to the **FM Rate** softkey in the initial FM Menu and the **FM Tone 1 Rate** softkey in the FM Dual-Sine Menu. Any value set for **FM Start Rate** is reflected in the **FM Rate** and **FM Tone 1 Rate** softkeys. Conversely, if you change the value for either the **FM Rate** softkey or the **FM Tone 1 Rate** softkey, the value for **FM Start Rate** is changed to match.

Default Value: 400.0 Hz

Softkey Location: **FM/ΦM** > **FM Waveform** > **Swept-Sine** > **FM Start Rate**

FM Stop Rate

Changes the ending internal modulation frequency for swept-sine frequency modulation. The current value for the FM stop rate is displayed in the active entry area. To enter a new value, rotate the front panel knob until the desired value is displayed, use the up and down arrow keys, or enter the value using the numeric keypad and press the Hz or kHz terminator softkey. The range of values allowed is 0.1 Hz to 50 kHz. The minimum increment allowed is 0.1 Hz.

This softkey is coupled to the **FM Tone 2 Rate** softkey in the FM Dual-Sine Menu. Any value set for **FM Stop Rate** is reflected in the **FM Tone 2 Rate** softkey. Conversely, if you change the value for the **FM Tone 2 Rate** softkey, the value for **FM Stop Rate** is changed to match.

Default Value: 400.0 Hz

Softkey Location: **FM/ΦM** > **FM Waveform** > **Swept-Sine** > **FM Stop Rate**

FM Sweep Time

Sets the sweep time for swept-sine frequency modulation. The signal generator will vary the FM rate from the specified start rate to the stop rate in the time set with this softkey. Enter the desired sweep time using the up and down arrow keys, the front panel knob, or enter a value using the numeric keypad and press the **sec** or **msec** terminator softkey. The range of values allowed is 1 ms through 65.535 s. The minimum increment allowed is 1 ms.

Default Value: 100.0 msec

Softkey Location: **FM/ΦM** > **FM Waveform** > **Swept-Sine** > **FM Sweep Time**

FM Sweep Trigger

Pressing this softkey reveals a menu of choices for triggering swept-sine frequency modulation. You can choose triggering that occurs immediately, triggering that is supplied via the GPIB bus, triggering on either the positive or negative edge of a signal supplied to the TRIGGER IN connector, external triggering, or triggering by the front panel Trigger key.

Default Value: Immediate

Softkey Location: **FM/ΦM** > **FM Waveform** > **Swept-Sine** > **FM Sweep Trigger**

FM Tone 1 Rate

Press this softkey to set the internal modulation frequency for the FM tone 1. Enter the desired rate using the up and down arrow keys, the front panel knob, or enter a value using the numeric keypad and press the kHz or Hz terminator softkey. The range of values allowed is 0.1 Hz through 50 kHz. The minimum increment allowed is 0.1 Hz.

This softkey is coupled to the **FM Rate** softkey in the initial FM Menu and the **FM Start Rate** softkey in the FM Swept-Sine Menu. Any value set for **FM Tone 1 Rate** is reflected in the **FM Rate** and **FM Start Rate** softkeys. Conversely, if you change the value for either the **FM Rate** softkey or the **FM Start Rate** softkey, the value for **FM Tone 1 Rate** is changed to match.

Default Value: 400.0 Hz

Softkey Location: **FM/ΦM** > **FM Waveform** > **Dual-Sine** > **FM Tone 1 Rate**

FM Tone 2 Ampl Percent Of Peak

Press this softkey to set the amplitude of the alternate frequency/rate as a percent of the peak LF analog modulation amplitude. The primary frequency/rate will make up the remaining amplitude. This softkey is for use with dual-sine modulation only.

For example, if the Tone 2 amplitude is 0%, then there would be no amplitude for Tone 2; all of the signal strength would be present in Tone 1. If **FM Tone 2 Ampl Percent Of Peak** is set to 50%, then Tone 2 and Tone 1 would have equal amplitudes, or half of the amplitude of both tones combined.

Default Value: 50.0%

Softkey Location: **FM/ΦM** > **FM Waveform** > **Dual-Sine** > **FM Tone 2 Ampl Percent Of Peak**

FM Tone 2 Rate

Press this softkey to set the internal modulation frequency for the FM tone 2. Enter the desired rate using the up and down arrow keys, the front panel knob, or enter a value using the numeric keypad and press the kHz or Hz terminator softkey. The range of values allowed is 0.1 Hz through 50 kHz. The minimum increment allowed is 0.1 Hz.

This softkey is coupled to the **FM Stop Rate** softkey in the FM Swept-Sine Menu. Any value set for **FM Tone 2 Rate** is reflected in the **FM Stop Rate** softkey. Conversely, if you change the value for the **FM Stop Rate** softkey, the value for **FM Tone 2 Rate** is changed to match.

Default Value: 400.0 Hz

Softkey Location: **FM/ΦM** > **FM Waveform** > **Dual-Sine** > **FM Tone 2 Rate**

FM Waveform

Pressing this softkey reveals a menu of FM waveform choices for your **FM Path 1** and **FM Path 2** configurations. Select from sine, triangle, square, ramp, noise, dual-sine, and swept-sine waveforms. Notice that your waveform selection applies only to whichever FM path configuration you have currently selected.

Default Value: Sine

Softkey Location: **FM/ΦM** > **FM Waveform**

Immediate

This softkey is one of the choices in the FM Sweep Trigger menu. Choosing **Immediate** immediately triggers swept-sine frequency modulation in a continuous mode. To stop the sweep, choose a different trigger such as **Ext**, or set the waveform to something other than **Swept-Sine**.

Softkey Location: **FM/ΦM** > **FM Waveform** > **Swept-Sine** > **FM Sweep Trigger** > **Immediate**

Internal

This softkey lets you internally generate an AC-coupled, frequency modulation signal.

The internal source has multiple uses but can be used for only one modulation at a time. If, for example you were using the internal source in an amplitude modulation configuration for **AM Path 1**, and then you configured **FM Path 2** to also use the internal source, the signal generator would turn off **AM Path 1** and assign the internal source to your **FM Path 2** configuration.

Softkey Location: **FM/ΦM** > **FM Source** > **Internal**

Noise

This softkey lets you specify noise as the frequency modulation waveform for the **FM Path 1** and **FM Path 2** configurations. Notice that the selected waveform applies only to whichever FM path configuration you have currently selected.

Softkey Location: **FM/ΦM > FM Waveform > Noise**

Ramp

This softkey lets you specify ramp as the frequency modulation waveform for the **FM Path 1** and **FM Path 2** configurations. Notice that the selected waveform applies only to whichever FM path configuration you have currently selected.

Softkey Location: **FM/ΦM > FM Waveform > Ramp**

Sine

This softkey lets you specify sine as the frequency modulation waveform for the **FM Path 1** and **FM Path 2** configurations. Notice that the selected waveform applies only to whichever FM path configuration you have currently selected.

Softkey Location: **FM/ΦM > FM Waveform > Sine**

Square

This softkey lets you specify square as the frequency modulation waveform for the **FM Path 1** and **FM Path 2** configurations. Notice that the selected waveform applies only to whichever FM path configuration you have currently selected.

Softkey Location: **FM/ΦM > FM Waveform > Square**

Swept-Sine

Pressing this softkey reveals a menu of choices for setting the swept-sine frequency modulation parameters. In this menu you can set the start and stop FM rate and the sweep time. You can set the signal generator to a single, externally-triggered sweep on either a negative or positive TTL level or you can choose continuous sweep, triggered immediately. In this menu you can also select either a positive or negative polarity for the TRIGGER OUT signal.

Softkey Location: **FM/ΦM > FM Waveform > Swept-Sine**

Triangle

This softkey lets you specify triangle as the frequency modulation waveform for the **FM Path 1** and **FM Path 2** configurations. Notice that the selected waveform applies only to whichever FM path configuration you have currently selected.

Softkey Location: **FM/ΦM > FM Waveform > Triangle**

Trigger In Polarity Neg Pos

Press this softkey to toggle between a negative TTL level trigger (0 V) and a positive TTL level trigger (+5 V) for externally triggering swept-sine frequency modulation.

This softkey is coupled to the **Trigger In Polarity Neg Pos** softkey for swept-sine AM, ΦM, and LF Out, and to the **Ext Neg** and **Ext Pos** sweep trigger selections in the Sweep/List Menu. If you set the **Trigger In Polarity Neg Pos** softkey in the FM Swept-Sine Menu to **Neg**, the **Trigger In Polarity Neg Pos** softkey is also set to **Neg** for swept-sine AM, ΦM, and LF Out. And, in addition, if the step or list sweep trigger is set to **Ext Pos**, the trigger selection will automatically be changed to **Ext Pos**. The same softkeys will toggle to **Pos** or to **Ext Pos** if you select **Pos** in the Swept-Sine FM Menu.

Conversely, if the **Trigger In Slope Neg Pos** softkey is toggled in the swept-sine AM, ΦM, or LF Out menus, it will cause the swept-sine FM softkey to toggle also. This is also true for the **Ext Neg** and **Ext Pos** step or list sweep trigger selections.

Default Value: Pos

Softkey Location: **FM/ΦM > FM Waveform > Swept-Sine > Trigger In Polarity Neg Pos**

Trigger Key

This softkey is one of the choices in the FM Sweep Trigger menu. With **Trigger Key** selected, when you press the **Trigger** front panel key you immediately trigger a single sweep of swept-sine frequency modulation.

The **Trigger** key has autorepeat capability. Hold it down and you will repeatedly trigger sweeps until you release the key.

Softkey Location: **FM/ΦM > FM Waveform > Swept-Sine > FM Sweep Trigger > Trigger Key**

Trigger Out Polarity Neg Pos

This softkey toggles the polarity of the TTL signal that is output at the rear panel TRIGGER OUT connector. When **Trigger Out Polarity Neg Pos** is set to **Pos**, the output signal is asserted high (+5 V) at the start of the swept-sine frequency modulation sweep and low (0 V) when the sweep is concluded. Setting **Trigger Out Polarity Neg Pos** to **Neg** reverses the polarity, where a high is 0 V and a low is +5 V.

This softkey is coupled to the **Trigger Out Polarity Neg Pos** softkey in the swept-sine AM, Φ M, and LF Out menus and the sweep/list menu. When the polarity is toggled for this softkey in any one of these menus, it affects all locations of the softkey.

Default Value: Pos

Softkey Location: **FM/ Φ M > FM Waveform > Swept-Sine > Trigger Out Polarity Neg Pos**

Freq

Pressing the front panel **Freq** key reveals a menu of softkeys. These softkeys are described in this section in alphabetical order.

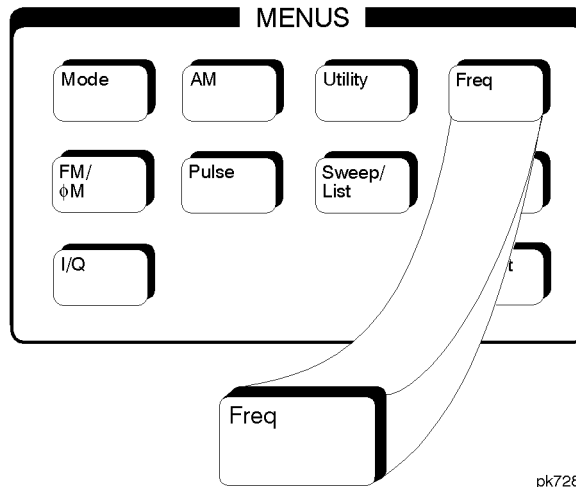

Adjust Phase

Use this softkey to change the phase of the RF OUTPUT signal. You can change the phase relative to whatever phase the signal generator locked to the last time it changed frequency. For this reason, the phase adjustment does not survive changes in frequency and must be readjusted. If you first press **Phase Ref Set**, the current output phase is set as a zero reference and any subsequent phase adjustment is displayed as relative to the zero reference. Phase adjustment cannot be used with frequency or phase modulation.

To change the phase, press the softkey once. Phase adjustment becomes the active function. To enter a new value, rotate the front panel knob until the desired value is displayed, use the up and down arrow keys, or enter the value using the numeric keypad and press the **rad** or **deg** terminator softkey. The range of values allowed is ± 3.141 radians or ± 180 degrees.

Default Value: 0 radians

Softkey Location: **Freq** > **Adjust Phase**

Freq Multiplier

You can multiply the frequency shown on the display without changing the frequency output at the RF OUTPUT connector (simulating the frequency at the output of a harmonic multiplier). Press this softkey and enter a value from 1 through 50. Use the up and down arrow keys, the front panel knob, or enter a value using the numeric keypad and press the **Enter** terminator softkey. For example, set the output frequency to 1 MHz. Then press **Freq > Freq Multiplier > 3 > Enter**. The display will now show an output frequency of 3 MHz but the actual output frequency will remain at 1 MHz. For any multiplier greater than 1, the **MULT** indicator is shown in the frequency area of the display.

Default Value: 1

Softkey Location: **Freq > Freq Multiplier**

Freq Offset

Press this softkey to set a value for frequency offset. A frequency offset changes the value shown in the frequency area of the display but does not affect the output frequency. For example, if the current output frequency is 1 MHz and you enter a frequency offset of 3 MHz, the output frequency will remain at 1 MHz but the display will show a frequency of 4 MHz. This feature lets you simulate the frequency at the output of a frequency translating device.

A frequency offset can be entered at any time during normal operation and also when you are operating in frequency reference mode. To enter an offset, press **Freq Offset** and enter the desired frequency value using the up and down arrow keys, the front panel knob, or enter a value using the numeric keypad and press the **Hz**, **kHz**, **MHz**, or **GHz** terminator softkey. When an offset has been entered, the **OFFSET** indicator is turned on in the frequency area of the display.

Default Value: 0 Hz

Softkey Location: **Freq > Freq Offset**

Freq Ref Off On

This softkey toggles the frequency reference mode on and off. When frequency reference mode is turned on, the frequency value displayed is equal to the current hardware output frequency minus the reference value set by the **Freq Ref Set** softkey. (The **Freq Ref Set** softkey sets the reference value equal to the current output frequency. If you have not yet set the reference value, the preset value for frequency reference is 0 Hz.) The REF indicator is turned on in the frequency area of the display. All frequency parameters will now be set as relative to the reference value.

Frequency offsets can be used with frequency reference mode. In this situation, the display will show the frequency calculated as the current hardware output frequency minus the reference value plus the frequency offset.

Frequency reference mode only changes the display; it does not change the RF output frequency. For example, if you set your RF output frequency to 700 MHz, set your reference value, and then turn frequency relative mode on, your display shows your frequency as 0 Hz but your output frequency remains at 700 MHz.

Default Value: Off

Softkey Location: Freq > Freq Ref Off On

Freq Ref Set

This softkey sets the current output frequency as a frequency reference value. It also causes the **Freq Ref Off On** softkey to toggle to the **On** position, turning on frequency reference mode. All frequency parameters are then set as relative to the reference value.

Default Value: Off

Softkey Location: Freq > Freq Ref Set

Mode 1 Optimize <10kHz Offset

Press this softkey to set the signal generator to mode 1 which optimizes phase noise at offsets below 10 kHz.

Softkey Location: Freq > Optimize Φ Noise > Mode 1 Optimize > 10k Offset

Mode 2 Optimize >10kHz Offset

Press this softkey to set the signal generator to mode 2 which optimizes phase noise at offsets above 10 kHz.

Softkey Location: Freq > Optimize Φ Noise > Mode 2 Optimize > 10k Offset

Optimize Φ Noise

Press this softkey for two choices in optimizing phase noise. You can choose to set the phase-lock loop bandwidth to optimize phase noise for offsets below or above 10 kHz offsets as shown in [Figure 4-1](#). This softkey is present on ESG-A and ESG-D series instruments only.

Figure 4-1 Phase Noise Performance Mode 1 Versus Mode 2

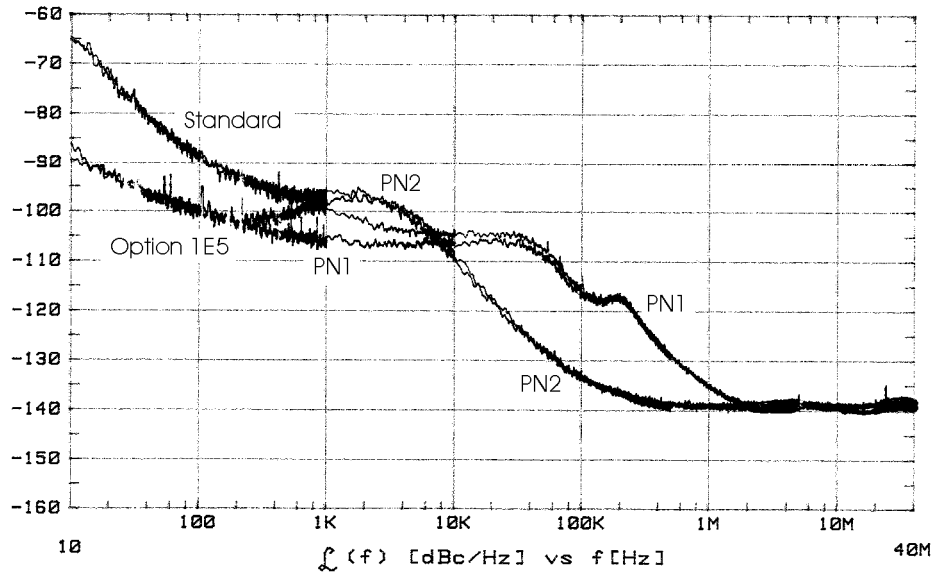

pk74b

Default Value: Mode 2

Softkey Location: Freq > Optimize Φ Noise

Phase Ref Set

This softkey sets the current output phase as a zero reference. All phase parameters are then set as relative to the zero reference.

Softkey Location: Freq > Phase Ref Set

Ref Oscillator Source Auto Off/On

This softkey switches off and on the signal generator's capability of automatically selecting between the internal reference oscillator and an external reference oscillator. When this function is turned on, the signal generator detects when a valid reference signal is present at the 10 MHz IN connector and automatically switches from internal to external reference operation. Conversely, when this function is turned off, the signal generator uses the internal reference only, even if an external reference is connected.

Default Value: On

Softkey Location: Freq > Ref Oscillator Source Auto Off On

Frequency

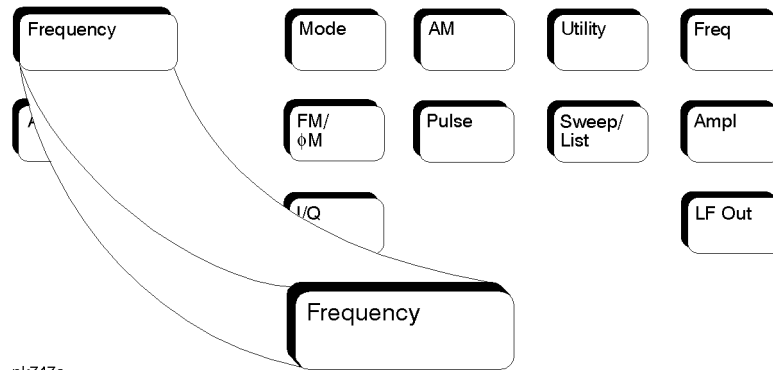

pk747a

Press this front panel hardkey to change the RF output frequency. Frequency becomes the active function and the current value is also shown in the active entry area of the display. To enter a new value for frequency, rotate the front panel knob until the desired value is displayed, use the up and down arrow keys, or enter the value using the numeric keypad and press the **GHz**, **MHz**, **kHz**, or **Hz** terminator softkey. The output frequency range allowed depends on your instrument model. Refer to the technical specifications document.

The current RF output frequency is always shown in the frequency area of the display (unless you have altered the display by turning on frequency reference mode or entering an offset or a multiplier). The frequency area of the display is blanked whenever a frequency sweep is selected.

Default Value: Maximum specified output frequency

Help

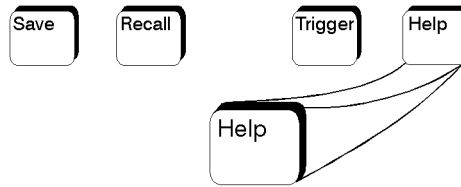

pk754a

Press this hardkey for a short description of the function of any front panel hardkey or softkey. When you press the **Help** key, the following message is displayed:

- Press a key for help on that key.

Press a front panel hardkey or a softkey and a short description of that key's function will be displayed. Press another key and you will be returned to normal instrument operation.

The **Help** key can be set to either single or continuous mode. In single mode, when you press the **Help** key, help text is provided only for the next key that you press and then you are returned to normal operation. In continuous mode, when you press the **Help** key, help text is provided for the next key that you press and that key's function is also executed (except for the **Preset** key). This help mode remains active until you press the **Help** key again.

Refer to the description of the **Help Mode Single Cont** softkey in the Utility section for instructions on changing the help mode from single to continuous.

Hold

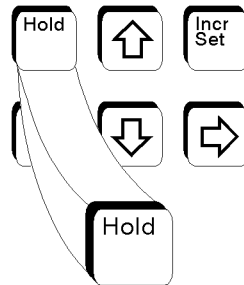

pk748a

Press this front panel hardkey to de-activate the current active function and blank the softkey menu. Once **Hold** is pressed, the front panel knob, the arrow keys, and the numeric keypad have no effect.

To return to normal operation, press any front panel hardkey.

Incr Set

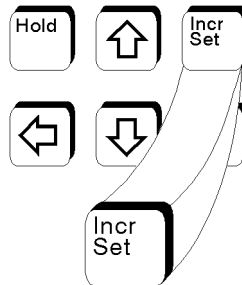

pk749a

Press this front panel hardkey to change the incremental value of the up and down arrow keys for the current active function. For example, press **Frequency** to make it the active function. The current frequency is shown in the active entry area. The incremental value for frequency is set to 1 MHz at the factory. Press **Incr Set** and the incremental value of the up and down arrow keys for frequency becomes the active function. You can change the value by using three different methods:

- Use the up and down arrow keys. The arrow keys will change the incremental value in steps equal to the current incremental value (in this example, these are 1 MHz steps.)
- Use the front panel knob.
- Use the numeric keypad and complete your entry with a terminator softkey.

Press **Incr Set** again and the active function toggles, making frequency the active function again.

Incremental values are persistent states; they are not affected by an instrument preset or by a power cycle.

I/Q

This front panel hardkey and its menus are only available on ESG-D and ESG-DP Series Signal Generators. The softkeys in the I/Q menus are described in this section in alphabetical order.

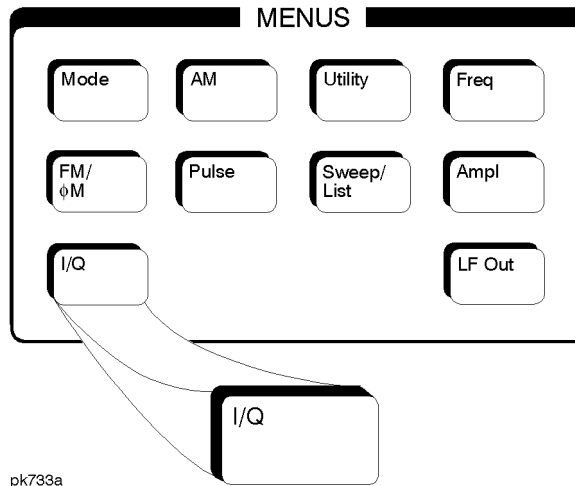

ALC Off On

Press this softkey to Toggle the automatic leveling control (ALC) circuit off and on.

The ALC is normally on. The RF output power of the signal generator is constantly monitored and controlled by the ALC circuit. Its purpose is to hold output power at its desired level in spite of drift due to temperature and time.

There are some modulation conditions which the ALC circuit cannot handle properly which lead to output level errors. In these conditions, better power level accuracy can be obtained by turning the ALC off and using power search. (Refer to the [Power Search Manual Auto](#) softkey documented in this section for more information about power search.) ALC off is useful with pulse modulation with a pulse width narrower than 2 μs and with certain external I/Q modulation.

Pulse modulation is accomplished using a modulator which precedes the ALC detector. The ALC must, therefore, measure a pulsed signal, and it is able to do this if the pulse width exceeds 2 μs. For narrower pulses, set the ALC softkey to Off.

With external I/Q modulation, the ALC loop acts to hold the signal generator's average output power constant, in spite of variations in the I/Q input power ($I^2 + Q^2$). Rapid variations of ($I^2 + Q^2$) propagate to the output, while slow variations are removed by the ALC loop, with a high-pass corner of 1 kHz. If you do not want this high-pass filtering,

set the **ALC Off On** softkey to **Off**. With ALC off, the I/Q modulation will be DC-coupled. Using power search, power level accuracy is preserved if $\sqrt{I^2 + Q^2} = 0.5 V_{\text{rms}}$.

When ALC is off, the **ALC OFF** display annunciator will turn on.

Default Value: On

Softkey Location: I/Q > **ALC Off On**

Burst Envelope Off On

Toggles on and off the burst envelope modulator. The burst envelope modulator is used to burst the RF carrier. When the **Burst Source** softkey is set to **Ext1 DC**, the shape of the burst output is the same as the shape of the EXT 1 analog input. The **Burst Envelope Off On** softkey is toggled automatically to **On** when any enabled digital modulation format also has burst turned on (Option UN8). Whenever the burst envelope modulator is on, the **ENVLP** annunciator is turned on in the display.

Default Value: Off

Softkey Location: I/Q > **Burst Envelope Off On**

Burst Source

Changes the source for burst modulation. If you do not have Option UN8, your only choice is a DC-coupled, analog input using the EXT 1 INPUT connector. Using this selection, the burst output signal will have the same shape as the analog input. If you have Option UN8, this softkey will automatically toggle to **Int Burst** if you have turned on burst for an enabled digital modulation format. In this mode, the internal baseband generator bursts the RF carrier. You can override this automatic selection by selecting **Ext1 DC** as the **Burst Source**. As long as burst is turned on in an enabled digital modulation format, you can toggle between the internal and external burst sources.

Default Value: Ext1 DC

Softkey Location: I/Q > **Burst Source**

Calibration Type User Full

Toggles between an I/Q calibration executed over the full frequency range of the signal generator (**Full**) or an I/Q calibration over a frequency range which you specify (**User**) using the **Start Frequency** and **Stop Frequency** softkeys. Once you have chosen either **Full** or **User**, and specified the frequency range, press **Execute Cal** to start the I/Q calibration.

The I/Q calibration type is a persistent state; it is not affected by an instrument preset or by a power cycle.

Softkey Location: **I/Q > I/Q Calibration > Calibration Type User Full**

Do Power Search

Press this softkey to execute the power search routine one time. Power search is an internal calibration routine used to achieve calibrated output power when the ALC is off. You can execute a power search at any time by pressing this softkey. If you are using external I/Q modulation, the power search routine assumes that the I/Q input level is $\sqrt{I^2 + Q^2} = 0.5 V_{\text{rms}}$. Actual output amplitude will scale directly with $\sqrt{I^2 + Q^2}$.

The **ALC Off On** softkey must be set to **Off** in order to execute the power search routine.

Softkey Location: **I/Q > ALC Off On > Do Power Search**

Execute Cal

Press this softkey to begin the I/Q calibration for the frequency range that you have specified. The calibration can be aborted at any time during the procedure by pressing the **Abort Cal** softkey. If you do abort the calibration, the previous calibration is restored.

Softkey Location: **I/Q > I/Q Calibration > Execute Cal**

Ext1 DC

Press this softkey to change the burst source for modulation to a DC-coupled, analog input using the EXT 1 INPUT connector. Using this selection, the burst output signal will have the same shape as the analog input. If you do not have Option UN8, this is the only burst source and it cannot be changed. If you have Option UN8, the burst source can also be set to an internal source (refer to the [Int Burst](#) softkey).

Softkey Location: **I/Q > Burst Source > Ext1 DC**

Ext I/Q

Press this softkey to change the I/Q source to externally supplied I and Q signals. Apply the in-phase and quadrature-phase signals to the I INPUT and Q INPUT connectors. The recommended signal level is $\sqrt{I^2 + Q^2} = 0.5 V_{\text{rms}}$. With equal levels at I and Q, as is usually the case, this is equivalent to $0.35 V_{\text{rms}}$ simultaneously at I and Q. For typical $\pi/4$ DQPSK signals, a $0.35 V_{\text{rms}}$ waveform will be approximately 1.3 Vp-p, whereas for GMSK it will be 1.0 Vp-p. If you do not have Option UN8, this is the only I/Q source and it cannot be changed. If you have Option UN8, the I/Q source can also be set to an internal I/Q source (refer to the [Int Burst](#) softkey).

Softkey Location: I/Q > I/Q Source > Ext I/Q

Ext I/Q Phase Polarity Normal Invert

Press this softkey to toggle between the Normal and Invert settings for external I/Q phase polarity. In the inverted mode, the input applied to the I INPUT connector is physically routed to the Q input port of the internal I/Q modulator. In addition, the input applied to the Q INPUT connector is physically routed to the I input port of the internal I/Q modulator. This inverts the direction of phase rotation of the I/Q modulation. If you have enabled a digital modulation format (Option UN8 only), I/Q phase polarity will be automatically set to normal. You can override this setting with this key.

Default Value: Normal

Softkey Location: I/Q > Ext I/Q Phase Polarity Normal Invert

High Crest Mode Off On

Press this softkey to toggle high crest mode off and on. Turn high crest mode on with externally-applied signals with high crest factors (such as CDMA). High crest mode allows the signal generator to process these signals with less distortion. With high crest factor signals, it is recommended that the I and Q inputs seldom exceed 1.0 Vp-p. Some output power and power level accuracy is sacrificed in this mode. This softkey is active only if the I/Q source is external and I/Q is turned on.

Default Value: Off

Softkey Location: I/Q > I/Q Off On > High Crest Mode Off On

I Offset

Press this softkey to enter an origin offset voltage for internally-generated or externally-applied in-phase signals. Enter the value as a percentage of full scale (500 mV). The range of values allowed is -100% to +100%. Change the origin offset to adjust out imperfections in the in-phase signal or to introduce calibrated impairments. Set the origin offset as desired and then toggle the **I/Q Adjustments Off On** softkey to **On**.

When using this key to minimize the LO feedthrough signal, optimum performance is achieved when the adjustment is made after all other I/Q path adjustments, such as those made with the [Int Phase Polarity Normal Invert] or [Modulator Atten xx db Manual Auto] softkeys. If other adjustments are made after minimization is performed, the LO feedthrough signal may increase.

Default Value: 0.0%

Softkey Location: **I/Q > I/Q Adjustments > I Offset**

I/Q Adjustments

Pressing this softkey reveals a menu of I/Q adjustment choices for internally generated or externally applied I and Q signals. In this menu you can change the I to Q gain ratio, change the I and Q offset voltages, change quadrature skew, and turn on and off these I/Q adjustments.

Default Value: Off

Softkey Location: **I/Q > I/Q Adjustments**

I/Q Adjustments Off On

Press this softkey to toggle off and on the I to Q gain ratio and the I and Q offset voltage adjustments. The values entered for the **I/Q Gain**, **I Offset**, and **Q Offset** are not applied to the I and Q signals until the **I/Q Adjustments Off On** softkey is set to **On**.

Default Value: Off

Softkey Location: **I/Q > I/Q Adjustments > I/Q Adjustments Off On**

I/Q Calibration

Pressing this softkey reveals a menu of choices for executing an I/Q calibration. An I/Q calibration should be performed approximately every 30 days, but it can be performed at any time to peak the performance of the I/Q modulator. You can set the start and stop frequency for a user-defined I/Q calibration, or choose an I/Q calibration over the signal generator's entire frequency range. In this menu, you

can also restore the values for the I/Q calibration performed at the factory (the instrument discards the latest calibration data and uses the data installed by the factory).

Softkey Location: **I/Q > I/Q Calibration**

I/Q Gain

Press this softkey to change the I to Q gain ratio. For example, if you enter in a value of +1 dB, the I signal will have 1 dB more amplitude than the Q signal. The range of gain adjustment values allowed is -4 dB to +4 dB. The gain ratio adjustment can be used with externally-applied I and Q signals or with internally-generated I and Q signals. Change the gain ratio to adjust out imperfections in I and Q or to introduce calibrated impairments. Set the gain ratio as desired and then toggle the **I/Q Adjustments Off On** softkey to **On**.

Default Value: 0 dB

Softkey Location: **I/Q > I/Q Adjustments > I/Q Gain**

I/Q Off On

This softkey enables the I/Q modulation. Notice, however, that although you can enable I/Q modulation with this softkey, the RF carrier is modulated only when you have also set **Mod On/Off** to **On**. **I/Q Off/On** is also toggled automatically to **On** when any of the digital modulation formats are enabled (Option UN8). However, you can turn off the I/Q modulation with this softkey even though the digital modulation mode is enabled. With this configuration, the RF output signal would not be modulated but the I/Q signals will be present at the rear panel I/Q outputs. Whenever I/Q modulation is enabled, the I/Q annunciator is turned on in the display.

Default Value: Off

Softkey Location: **I/Q > I/Q Off On**

I/Q Source

Pressing this softkey reveals a menu of I/Q source choices. If you have enabled a digital modulation format (Option UN8 only), the signal generator is automatically set to internally generate I and Q signals (**Int I/Q**). You cannot use the internal source unless you have also enabled a digital modulation format. You can externally supply the I and Q signals via the I INPUT and Q INPUT connectors by pressing **Ext I/Q**. Apply the in-phase and quadrature-phase signals to the I and Q inputs. The signal level is $\sqrt{I^2 + Q^2} = 0.5 V_{\text{rms}}$. (See the sections on **Ext I/Q** and **High Crest Mode**.)

Default Value: Ext I/Q

Softkey Location: **I/Q > I/Q Source**

Int Burst

This softkey is automatically selected for the burst source when you have enabled one of the digital modulation formats with burst on (Option UN8 only). In this mode, the internal baseband generator bursts the RF carrier. You can override this automatic selection by selecting **Ext1 DC** as the **Burst Source**. As long as burst is turned on in an enabled digital modulation format, you can toggle between the internal and external burst sources.

Softkey Location: **I/Q > Burst Source > Int Burst**

Int I/Q

This softkey is automatically selected for the I/Q source when you have enabled a digital modulation format (Option UN8 only). In this mode, the signal generator is automatically set to internally generate I and Q signals. You can override this selection by setting the **I/Q Source** to **Ext1 I/Q**. As long as digital modulation is enabled, you can toggle between the internal and external I/Q sources.

Softkey Location: **I/Q > I/Q Source > Int I/Q**

Power Search Manual Auto

This softkey toggles between the auto and manual modes of power search mode. Power search is an internal calibration routine used to achieve calibrated output power when the ALC is off. When you set **Power Search Manual Auto** to **Auto**, power search will execute automatically with each change to the RF frequency or power, and also with each change to the AM, burst, pulse, or I/Q modulation state. If you are using external I/Q modulation, the power search routine assumes that the I/Q input level is $\sqrt{I^2 + Q^2} = 0.5 V_{\text{rms}}$. Actual output amplitude will scale directly with $\sqrt{I^2 + Q^2}$.

When you set **Power Search Manual Auto** to **Manual**, the power search routine is not run until the **Do Power Search** softkey is pressed.

The **ALC Off On** softkey must be set to **Off** in order to engage either power search mode.

Default Value: Manual

Softkey Location: **I/Q > ALC Off On > Power Search Manual Auto**

Q Offset

Press this softkey to enter an origin offset voltage for internally-generated or externally-applied quadrature-phase signals. Enter the value as a percentage of full scale (500 mV). The range of values allowed is -100% to $+100\%$. Change the origin offset to adjust out imperfections in the quadrature-phase signal or to introduce calibrated impairments. Set the origin offset as desired and then toggle the I/Q Adjustments Off On softkey to On.

Default Value: 0.0%

Softkey Location: I/Q > I/Q Adjustments > Q Offset

Quadrature Skew

Press this softkey to adjust the phase angle between the I and Q vectors. When the quadrature skew is zero, the phase angle is 90 degrees. Positive skew increases the angle from 90 degrees while negative skew decreases the angle from 90 degrees. The range of values allowed is ± 10 degrees with a minimum increment of 0.1 degrees. However, if you're operating the signal generator in the 3.3 to 4 GHz frequency range, quadrature skew settings greater than ± 5 degrees will not be within specifications.

Default Value: 0.0 deg

Softkey Location: I/Q > I/Q Adjustments > Quadrature Skew

Revert to Default Cal Settings

Press this softkey to restore the original factory calibration data for the internal I/Q modulator. The latest calibration data from the user calibration is discarded. Although the factory calibration data may not be optimized for the signal generator's present status, the data can be used as a starting point if the current data is lost (if the I/Q calibration is unable to execute).

Softkey Location: I/Q > I/Q Calibration > Revert to Default Cal Settings

Start Frequency

Press this softkey in the I/Q Calibration menu to set the start frequency for executing an I/Q calibration. You can select a portion of the frequency range for an I/Q calibration by selecting **Calibration Type User** and setting new start and stop frequencies. Limiting the frequency range of the calibration will decrease the time required for the calibration to be executed. To enter a frequency, rotate the front panel knob until the desired value is displayed, use the up and down arrow keys, or enter the value using the numeric keypad and press the **Hz**, **kHz**, **MHz**, or **GHz** terminator softkey. This softkey is automatically set to the minimum specified frequency of the signal generator if you have set the **Calibration Type User Full** softkey to **Full** (entire frequency range of the signal generator). The **User** value for **Start Frequency** is not changed, however. If you toggle back to **User** from the **Full** setting, notice that the **User** value is unchanged.

Start Frequency is a persistent state; it is not affected by an instrument preset or by a power cycle.

Softkey Location: **I/Q > I/Q Calibration > Start Frequency**

Stop Frequency

Press this softkey in the I/Q Calibration menu to set the stop frequency for executing an I/Q calibration. You can select a portion of the frequency range for an I/Q calibration by selecting **Calibration Type User** and setting new start and stop frequencies. Limiting the frequency range of the calibration will decrease the time required for the calibration to be executed. To enter a frequency, rotate the front panel knob until the desired value is displayed, use the up and down arrow keys, or enter the value using the numeric keypad and press the **Hz**, **kHz**, **MHz**, or **GHz** terminator softkey. This softkey is automatically set to the maximum specified frequency of the signal generator if you have set the **Calibration Type User Full** softkey to **Full** (entire frequency range of the signal generator). The **User** value for **Stop Frequency** is not changed, however. If you toggle back to **User** from the **Full** setting, notice that the **User** value is unchanged.

Stop Frequency is a persistent state; it is not affected by an instrument preset or by a power cycle.

Softkey Location: **I/Q > I/Q Calibration > Stop Frequency**

LF Out

Pressing the front panel **LF Out** key reveals a menu of softkeys for configuring the internal low frequency generator. These softkeys are described in this section in alphabetical order.

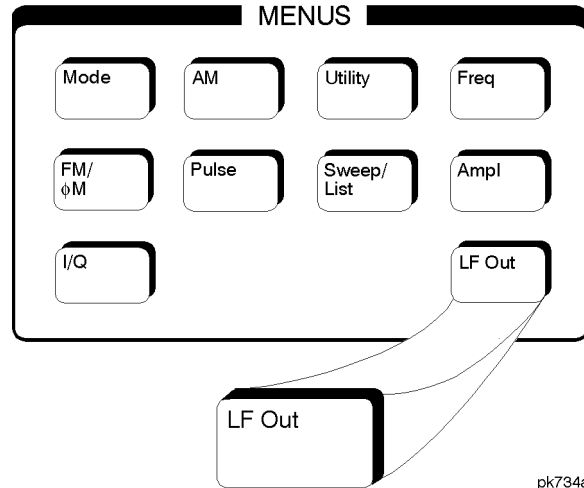

Bus

This softkey is one of the choices in the **LF Out Sweep Trigger** menu. With **Bus** selected, you use the GPIB to trigger single sweeps of swept-sine low frequency output.

Softkey Location: **LF Out > LF Out Source > Function Generator > LF Out Waveform > Swept-Sine > LF Out Sweep Trigger > Bus**

DC

This softkey lets you specify DC as the waveform for the LF output signal.

This softkey is only active when you have selected the internal source to operate as a function generator.

Softkey Location: **LF Out > LF Out Source > Function Generator > LF Out Waveform > DC**

Dual-Sine

Pressing this softkey reveals a menu of choices for setting the dual-sine low frequency output parameters. In this menu you can set the frequencies for two separate tones. In addition you can set a ratio of the tone 2 LF amplitude to the tone 1 LF amplitude.

Softkey Location: LF Out > LF Out Source > Function Generator > LF Out Waveform > Dual-Sine

Ext

This softkey is one of the choices in the LF Output Sweep Trigger menu. Choosing **Ext** allows you to trigger swept-sine low frequency output using the signal applied to the TRIGGER IN rear panel connector. Set the polarity of the trigger signal using the **Trigger In Polarity Neg Pos** softkey.

Softkey Location: LF Out > LF Out Source > Function Generator > LF Out Waveform > Swept-Sine > LF Out Sweep Trigger > Ext

Function Generator

This softkey lets you set the **LF Out Source** to be a function generator. You can select a frequency and shape in addition to selecting the amplitude for a signal that is output at the LF OUTPUT front panel connector. When you use the internal source in this capacity, any modulation with the internal source selected is turned off.

Softkey Location: LF Out > LF Out Source > Function Generator

Immediate

This softkey is one of the choices in the LF Output Sweep Trigger menu. Choosing **Immediate** immediately triggers swept-sine low frequency output in a continuous mode. To stop the sweep, choose a different trigger such as **Ext**, or set the waveform to something other than **Swept-Sine**.

Softkey Location: LF Out > LF Out Source > Function Generator > LF Out Waveform > Swept-Sine > LF Out Sweep Trigger > Immediate

Internal Modulation

This softkey lets you output a signal at the LF OUTPUT connector where the frequency and shape of the signal is set by the internal source as it is being used by a modulation. For example, if the internal source is currently assigned to an AM path configuration and AM is turned on, the signal output at the LF OUTPUT connector will have the frequency and shape of the amplitude modulating signal. You can scale the amplitude of the output signal using the **LF Out Amplitude** softkey.

For internal square pulse modulation, the internal source is a sinewave which is later squared by the modulator to generate the pulse squarewave. The LF OUTPUT signal for this internal source, therefore, is a sinewave. For internal pulse modulation, a true variable-width pulse will be seen on the LF OUTPUT.

Softkey Location: **LF Out > LF Out Source > Internal Modulation**

LF Out Amplitude

Use this softkey to scale the output of the signal at the LF OUTPUT connector. To change the value, press the softkey once. The current value for LF output amplitude is displayed in the active entry area. To enter a new value, rotate the front panel knob until the desired value is displayed, use the up and down arrow keys, or enter the value using the numeric keypad and press the **V**, or **mV** terminator softkey. The range of values allowed is 0 to 5 Vpk in increments from 1 mV to 5 V.

Default Value: 0V

Softkey Location: **LF Out > LF Out Amplitude**

LF Out Freq

Use this softkey to set the modulating frequency for the LF output signal when you have selected the internal source as a function generator. To change the frequency, press the softkey once. The current modulating frequency is displayed in the active entry area. To enter a new frequency, rotate the front panel knob until the desired value is displayed, use the up and down arrow keys, or enter the value using the numeric keypad and press the **Hz** or **kHz** terminator softkey. The range of frequencies allowed is 0.1 Hz to 10 kHz. (0.1 Hz to 50 kHz is the range allowed if sinewave is selected as the internal waveform.)

This softkey is only active when you have selected the internal source to operate as a function generator.

Default Value: 400 Hz

Softkey Location: **LF Out > LF Out Source > Function Generator > LF Out Freq**

LF Out Off On

This softkey toggles on and off the output of the selected source at the LF OUTPUT front panel connector. You can choose either the modulation signal generated by the internal source or you can use the low frequency source as a function generator and select that signal to output at the LF OUTPUT connector. Refer to the description of the [LF Out Source](#) softkey in this section for more information on choosing the source.

Once you have toggled this state on, the signal is immediately available at the LF OUTPUT connector. The **Mod On/Off** and **RF On/Off** keys do not apply to this state.

Default Value: Off

Softkey Location: **LF Out > LF Out Off On**

LF Out Period

Changes the pulse period for the pulsed low frequency waveform. To change the period, press the softkey once. The current value for pulse period is displayed in the active entry area. To enter a new value, rotate the front panel knob until the desired value is displayed, use the up and down arrow keys, or enter the value using the numeric keypad and press the **μsec** or **msec** terminator softkey. The range of values allowed is from 16 μs to 30 s. If you set the pulse period to a smaller value than the pulse width, an error message will be generated and the pulse width will be reduced to the value of the pulse period.

This softkey is only active when you have selected the internal source to operate as a function generator and when the LF Out waveform is specified as pulse.

Default Value: 80 μs

Softkey Location: **LF Out > LF Out Source > Function Generator > LF Out Waveform > Pulse > LF Out Period**

LF Out Source

Reveals a menu of choices for LF output sources. You can choose to output the signal from the internal source as it is being used by a modulation or you can use the internal source as a function generator and select that signal to output at the LF OUTPUT connector.

If you choose the internal source, the frequency and shape of the signal at the LF OUTPUT connector is set by the internal source as it is being used by a modulation. For example, if the internal source is currently assigned to an AM path configuration and AM is turned on, the signal output at the LF OUTPUT connector will have the frequency and shape of the amplitude modulating signal. You can scale the amplitude of the output signal using the **LF Out Amplitude** softkey.

If you choose to set the internal source as a function generator, you can select a frequency and shape in addition to selecting the amplitude for the LF output signal. When you use the internal source in this capacity, any modulation with the internal source selected is turned off.

Default Value: Internal Modulation

Softkey Location: **LF Out > LF Out Source**

LF Out Start Freq

Use this softkey to change the starting frequency for swept-sine low frequency output. To change the value, press the softkey once. The current value for the LF Out start frequency is displayed in the active entry area. To enter a new value, rotate the front panel knob until the desired value is displayed, use the up and down arrow keys, or enter the value using the numeric keypad and press the **Hz** or **kHz** terminator softkey. The range of values allowed is 0.1 Hz to 50 kHz. The minimum increment allowed is 0.1 Hz.

This softkey is coupled to the **LF Out Freq** softkey in the initial LF Out Menu and the **LF Out Tone 1 Freq** softkey in the LF Out Dual-Sine Menu. Any value set for **LF Out Start Freq** is reflected in the **LF Out Freq** and **LF Out Tone 1 Freq** softkeys. Conversely, if you change the value for either the **LF Out Freq** softkey or the **LF Out Tone 1 Freq** softkey, the value for **LF Out Start Freq** is changed to match.

This softkey is only active when you have selected the internal source to operate as a function generator.

Default Value: 400.0 Hz

Softkey Location: **LF Out > LF Out Source > Function Generator > LF Out Waveform > Swept-Sine > LF Out Start Freq**

LF Out Stop Freq

Use this softkey to change the ending frequency for swept-sine low frequency output. To change the value, press the softkey once. The current value for the LF Out stop frequency is displayed in the active entry area. To enter a new value, rotate the front panel knob until the desired value is displayed, use the up and down arrow keys, or enter the value using the numeric keypad and press the Hz or kHz terminator softkey. The range of values allowed is 0.1 Hz to 50 kHz. The minimum increment allowed is 0.1 Hz.

This softkey is coupled to the LF Out Tone 2 Freq softkey in the LF Out Dual-Sine Menu. Any value set for LF Out Stop Freq is reflected in the LF Out Tone 2 Freq softkey. Conversely, if you change the value for the LF Out Tone 2 Freq softkey, the value for LF Out Stop Freq is changed to match.

This softkey is only active when you have selected the internal source to operate as a function generator.

Default Value: 400.0 Hz

Softkey Location: LF Out > LF Out Source > Function Generator >
LF Out Waveform > Swept-Sine > LF Out Stop Freq

LF Out Sweep Time

Press this softkey to set the sweep time for low frequency swept-sine output. The signal generator will sweep from the specified start frequency to the stop frequency in the time set with this softkey. Enter the desired sweep time using the up and down arrow keys, the front panel knob, or enter a value using the numeric keypad and press the sec or msec terminator softkey. The range of values allowed is 1 ms through 65.535 s. The minimum increment allowed is 1 ms.

This softkey is only active when you have selected the internal source to operate as a function generator.

Default Value: 100.0 msec

Softkey Location: LF Out > LF Out Source > Function Generator >
LF Out Waveform > Swept-Sine > LF Out Sweep Time

LF Out Sweep Trigger

Pressing this softkey reveals a menu of choices for triggering swept-sine low frequency output. You can choose triggering that occurs immediately, triggering that is supplied by the GPIB, triggering on either a positive or negative level of a signal supplied to the TRIGGER IN connector, or triggering by the front panel **Trigger** key.

Default Value: Immediate

Softkey Location: **LF Out > LF Out Source > Function Generator > LF Out Waveform > Swept-Sine > LF Out Sweep Trigger**

LF Out Tone 1 Freq

Press this softkey to set the frequency for the LF Out tone 1. Enter the desired frequency using the up and down arrow keys, the front panel knob, or enter a value using the numeric keypad and press the **kHz** or **Hz** terminator softkey. The range of values allowed is 0.1 Hz through 50 kHz. The minimum increment allowed is 0.1 Hz.

This softkey is coupled to the **LF Out Freq** softkey in the initial LF Out Menu and the **LF Out Start Freq** softkey in the LF Out Swept-Sine Menu. Any value set for **LF Out Tone 1 Freq** is reflected in the **LF Out Freq** and **LF Out Start Freq** softkeys. Conversely, if you change the value for either the **LF Out Freq** softkey or the **LF Out Start Freq** softkey, the value for **LF Out Tone 1 Freq** is changed to match.

This softkey is only active when you have selected the internal source to operate as a function generator.

Default Value: 400.0 Hz

Softkey Location: **LF Out > LF Out Source > Function Generator > LF Out Waveform > Dual-Sine > LF Out Tone 1 Freq**

LF Out Tone 2 Ampl % Of Peak

Press this softkey to set the ratio of the peak amplitude of LF Out tone 2 to the peak amplitude of LF Out as a percent. The range of values allowed is 0 to 100%. The minimum increment allowed is 0.1%. The sum of the two LF Out amplitudes results in the total LF Out amplitude (set by the LF Out Amplitude softkey in the initial LF Out Menu).

For example, if the total LF Out amplitude is 300 mVp and you set LF Out Tone 2 Ampl % Of Peak to 33%, then the amplitude of LF Out tone 1 will be 200 mVp and the amplitude of LF Out tone 2 will be 100 mVp (33% of 300 mVp) so that the amplitude of the two tones adds up to 300 mVp (200 mVp plus 100 mVp).

This softkey is only active when you have selected the internal source to operate as a function generator.

Default Value: 50.0%

Softkey Location: LF Out > LF Out Source > Function Generator >
LF Out Waveform > Dual-Sine > LF Out Tone 2 Ampl % Of Peak

LF Out Tone 2 Freq

Press this softkey to set the frequency for the LF Out tone 2. Enter the desired frequency using the up and down arrow keys, the front panel knob, or enter a value using the numeric keypad and press the kHz or Hz terminator softkey. The range of values allowed is 0.1 Hz through 50 kHz. The minimum increment allowed is 0.1 Hz.

This softkey is coupled to the LF Out Freq softkey in the initial LF Out Menu and the LF Out Stop Freq softkey in the LF Out Swept-Sine Menu. Any value set for LF Out Tone 2 Freq is reflected in the LF Out Freq and LF Out Stop Freq softkeys. Conversely, if you change the value for either the LF Out Freq softkey or the LF Out Stop Freq softkey, the value for LF Out Tone 2 Freq is changed to match.

This softkey is only active when you have selected the internal source to operate as a function generator.

Default Value: 400.0 Hz

Softkey Location: LF Out > LF Out Source > Function Generator >
LF Out Waveform > Dual-Sine > LF Out Tone 2 Freq

LF Out Waveform

Pressing this softkey reveals a menu of LF output waveform choices for your LF function generator. Select from sine, dual-sine, swept-sine, triangle, ramp, square, pulse, noise, and DC waveforms.

This softkey is only active when you have selected the internal source to operate as a function generator.

Default Value: Sine

Softkey Location: LF Out > LF Out Source > Function Generator > LF Out Waveform

LF Out Width

Use this softkey to change the pulse width for the pulsed low frequency waveform. To change the width, press the softkey once. The current value for pulse width is displayed in the active entry area. To enter a new value, rotate the front panel knob until the desired value is displayed, use the up and down arrow keys, or enter the value using the numeric keypad and press the μsec or msec terminator softkey. The range of values allowed is from 8 μs to a maximum of the value for the pulse period.

This softkey is only active when you have selected the internal source to operate as a function generator and when the LF Out waveform is specified as pulse.

Default Value: 40 μs

Softkey Location: LF Out > LF Out Source > Function Generator > LF Out Waveform > Pulse > LF Out Width

Noise

This softkey lets you specify noise as the waveform for the LF output signal.

This softkey is only active when you have selected the internal source to operate as a function generator.

Softkey Location: LF Out > LF Out Source > Function Generator > LF Out Waveform > Noise

LF Out**Pulse**

This softkey lets you specify pulse as the waveform for the LF output signal. The signal shape can only be specified when you have selected the internal source to operate as a function generator. Use the **LF Out Period** and **LF Out Width** softkeys to define the pulse shape.

This softkey is only active when you have selected the internal source to operate as a function generator.

Softkey Location: **LF Out > LF Out Source > Function Generator > LF Out Waveform > Pulse**

Ramp

This softkey lets you specify ramp as the waveform for the LF output signal.

This softkey is only active when you have selected the internal source to operate as a function generator.

Softkey Location: **LF Out > LF Out Source > Function Generator > LF Out Waveform > Ramp**

Sine

This softkey lets you specify sine as the waveform for the LF output signal.

This softkey is only active when you have selected the internal source to operate as a function generator.

Softkey Location: **LF Out > LF Out Source > Function Generator > LF Out Waveform > Sine**

Square

This softkey lets you specify square as the waveform for the LF output signal.

This softkey is only active when you have selected the internal source to operate as a function generator.

Softkey Location: **LF Out > LF Out Source > Function Generator > LF Out Waveform > Square**

Swept-Sine

Pressing this softkey reveals a menu of choices for setting the swept-sine low frequency output. In this menu you can set the LF start and stop frequency and the sweep time. You can also set the trigger for the swept-sine output, and the polarity of the TRIGGER IN and TRIGGER OUT signals.

Softkey Location: LF Out > LF Out Source > Function Generator > LF Out Waveform > Swept-Sine

Triangle

This softkey lets you specify triangle as the waveform for the LF output signal.

This softkey is only active when you have selected the internal source to operate as a function generator.

Softkey Location: LF Out > LF Out Source > Function Generator > LF Out Waveform > Triangle

Trigger In Polarity Neg Pos

Press this softkey to toggle between a negative TTL level trigger (0 V) and a positive TTL level trigger (+5 V) for externally triggering swept-sine low frequency output.

This softkey is coupled to the **Trigger In Polarity Neg Pos** softkey for swept-sine AM, FM, and Φ M, and to the **Ext Neg** and **Ext Pos** sweep trigger selections in the Sweep/List Menu. If you set the **Trigger In Polarity Neg Pos** softkey in the LF Out Swept-Sine Menu to **Neg**, the **Trigger In Polarity Neg Pos** softkey is also set to **Neg** for swept-sine AM, FM, and Φ M. In addition, if the step or list sweep is set to externally trigger, the selection will automatically be set to **Ext Neg**. The same softkeys will toggle to **Pos** or to **Ext Pos** if you select **Pos** in the Swept-Sine LF Out Menu.

Conversely, if the **Trigger In Slope Neg Pos** softkey is toggled in the swept-sine AM, FM, or Φ M menus, it will cause the swept-sine LF Out softkey to toggle also. This is also true for the **Ext Neg** and **Ext Pos** step or list sweep trigger selections.

This softkey is only active when you have selected the internal source to operate as a function generator.

Default Value: Pos

Softkey Location: LF Out > LF Out Source > Function Generator > LF Out Waveform > Swept-Sine > LF Out Sweep Trigger > Ext > Trigger In Polarity Neg Pos

Trigger Key

This softkey is one of the choices in the LF Output Sweep Trigger menu. With **Trigger Key** selected, when you press the **Trigger** front panel key you immediately trigger a single sweep of swept-sine low frequency output.

The **Trigger** key has autorepeat capability. Hold it down and you will repeatedly trigger sweeps until you release the key.

Softkey Location: LF Out > LF Out Source > Function Generator > LF Out Waveform > Swept-Sine > LF Out Sweep Trigger > Trigger Key

Trigger Out Polarity Neg Pos

This softkey toggles the polarity of the TTL signal that is output at the rear panel TRIGGER OUT connector. When **Trigger Out Polarity Neg Pos** is set to **Pos**, the output signal is asserted high (+5 V) at the start of the swept-sine low frequency sweep and low (0 V) when the sweep is concluded. Setting **Trigger Out Polarity Neg Pos** to **Neg** reverses the polarity, where a high is 0 V and a low is +5 V.

This softkey is coupled to the **Trigger Out Polarity Neg Pos** softkey in the swept-sine AM, FM, and Φ M menus and the sweep/list menu. When the polarity is toggled for this softkey in any one of these menus, it affects all locations of the softkey.

This softkey is only active when you have selected the internal source to operate as a function generator.

Default Value: Pos

Softkey Location: LF Out > LF Out Source > Function Generator > LF Out Waveform > Swept-Sine > Trigger Out Polarity Neg Pos

Local

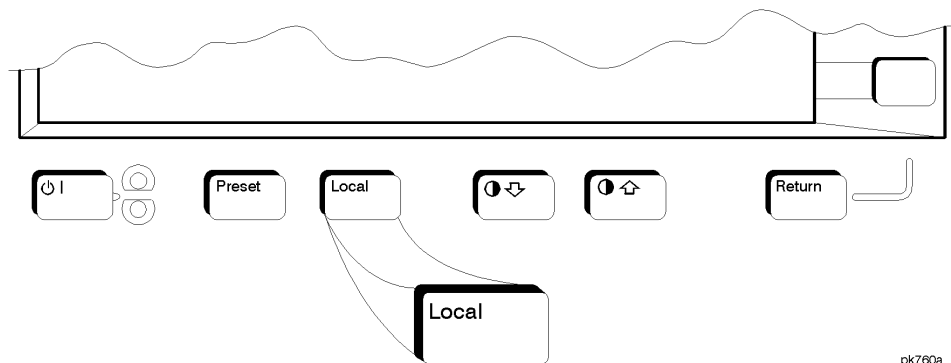

Press this key to return the signal generator to local (front panel) control from remote operation or to restore the front panel menu and status area display after RS-232 control. You can also press this key to restore the display once the screen saver has started.

This key has autorepeat capability. Hold it down and its function is continuously executed until you release it.

Default Value: Local (unless a LOCAL LOCKOUT command has been sent).

Mod On/Off

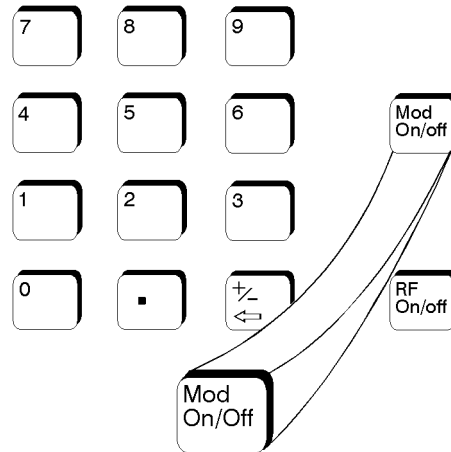

pk756a

Set this front panel hardkey to **On** to modulate the RF carrier with the modulations that you have enabled. All modulation types can be simultaneously enabled except FM with Φ M, AM with external burst source, and wideband AM with I/Q. An annunciator is always turned on in the display to indicate whether modulation is turned on or off.

Default Value: Mod Off

Mode

Pressing the front panel **Mode** key reveals a menu of softkeys. These softkeys let you access further menus for enabling options on digital ESG-D and ESG-DP series signal generators. These options are documented in separate user's and programming guides which are part of the digital documentation set.

On analog ESG-A and ESG-AP series signal generators, this front panel key is reserved for future use.

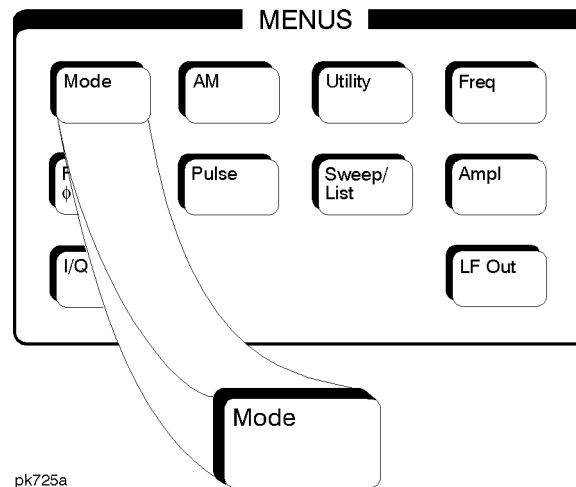

Numeric Keypad

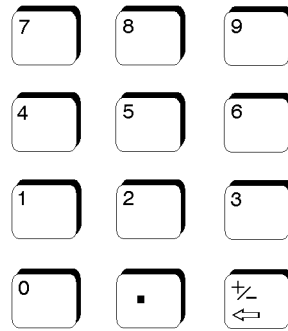

pk755a

The numeric keypad consists of the digit keys (0 through 9), a decimal point key, and a backspace key, . The backspace key has dual functions for both backspacing and for changing the sign of a value to positive or negative. Use these keys at any time when the active function requires a value input. The backspace key function changes with the situation.

If you are modifying a previously entered value:

- If the value is negative, pressing the backspace key deletes the entire value and leaves the negative sign. Subsequent key presses change the sign between positive and negative states.
- If the value is positive, pressing the backspace key deletes the entire value and also changes the sign to a negative state. Subsequent key presses change the sign between positive and negative states.

If you are entering a new value:

- If the cursor is to the right of the digits, pressing the backspace key deletes the digit immediately to the left. When no digits remain, subsequent key presses change the sign between positive and negative states.
- If the cursor is on a digit, pressing the backspace key deletes the digit immediately to the left. When a single digit remains, pressing the backspace key changes the negative sign (if present) to positive and then subsequent key presses have no effect.

These keys have autorepeat capability (except for the decimal point key). Hold a key down and its function is continuously executed until you release it.

Phase Modulation

Pressing the front panel phase modulation key (Φ M) reveals a menu of softkeys. These softkeys are described in this section in alphabetical order.

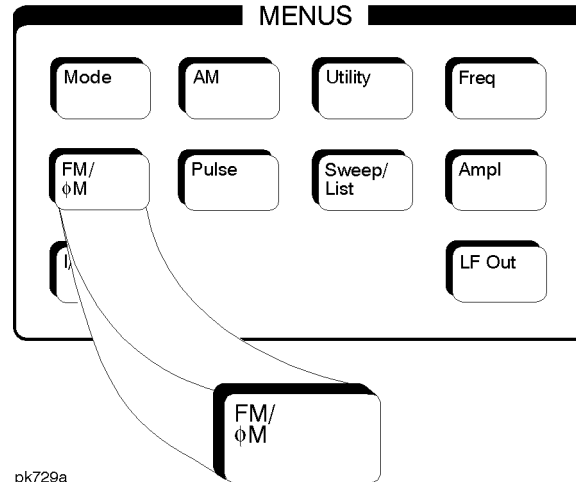

Φ M Dev

Use this softkey to set the phase modulation deviation for the Φ M Path 1 and Φ M Path 2 configurations. To change the value of the Φ M deviation, press the softkey once. The current value for Φ M deviation is displayed in the active entry area. To enter a new value, rotate the front panel knob until the desired value is displayed, use the up and down arrow keys, or enter the value using the numeric keypad and press the π rad, rad, or deg terminator softkey. The range of values allowed depends on the carrier frequency and the rate selected. Refer to [Table 4-2](#).

Table 4-2 Maximum Deviation Values for Phase Modulation

Mode	Maximum Deviation	Maximum Rates (3 dB BW)	
		Φ M Path 1	Φ M Path 2
Normal	$N^1 \times 90$ radians	100 kHz	100 kHz
High Bandwidth	$N \times 2\pi$ radians	1.5 MHz (typical)	1 MHz (typical)
	$N \times \pi/2$ radians	6 MHz (typical)	1 MHz (typical)

1. For the value of N, refer to [Table 4-3](#).

Table 4-3 Carrier Frequency Bands versus Value of N

Carrier Frequency	N
250 kHz to \leq 249.999 MHz	1
$>$ 249.999 MHz to \leq 500 MHz	0.5
$>$ 500 MHz to \leq 1 GHz	1
$>$ 1 GHz to \leq 2 GHz	2
$>$ 2 GHz to 4 GHz	4

For example, if you set up Φ M Path 1 for normal phase modulation with a carrier frequency of 400 MHz, and a rate of 100 kHz, the maximum peak deviation that you can set is 0.5 (value of N) times 90 radians resulting in a maximum peak deviation of 45 radians.

Notice that the new value of Φ M deviation applies only to whichever Φ M path configuration you have currently selected. Also, Φ M Path 2 is limited to a maximum rate of 1 MHz. Also, whenever Φ M Path 1 is used with Φ M Path 2, the deviation for Φ M Path 1 must be greater than or equal to the deviation for Φ M Path 2.

Default Value: 0 radians

Softkey Location: FM/ Φ M hardkey > FM Φ M softkey > Φ M Path 1 2

ΦM Dev Couple Off On

This softkey toggles the ΦM deviation coupling on and off. Turning on ΦM deviation coupling links the ΦM deviation values of ΦM Path 1 and ΦM Path 2. When the values are coupled, any change you make to one ΦM deviation value is applied to both ΦM deviation values.

Default Value: Off

Softkey Location: FM/ΦM hardkey > FM ΦM softkey ΦM >
ΦM Dev Couple Off On

ΦM Off On

This softkey toggles the phase modulation on or off for whichever ΦM configuration (ΦM Path 1 or ΦM Path 2) you have selected. Notice, however that although you can turn on phase modulation with this softkey, the RF carrier is modulated by the enabled modulation only when you have also set Mod On/Off to On. Whenever phase modulation is enabled, the ΦM annunciator is turned on in the display.

There are two paths for ΦM modulation which can be simultaneously enabled as long as they use different sources (Int, Ext1, or Ext2). ΦM Path 2 is limited to a maximum rate of 1 MHz. ΦM Path 2 must be set to a deviation less than or equal to ΦM Path 1. The modulation signals from both paths are summed internally for composite modulation.

Default Value: Off

Softkey Location: FM/ΦM hardkey > FM ΦM softkey ΦM > ΦM Off On

Φ M Path 1 2

Use Φ M Path 1 and Φ M Path 2 to define two unique phase modulation configurations. For example, select Φ M Path 1. (Φ M Path 1 is the default after a normal preset. If Φ M Path 1 is not highlighted, press the softkey once and the selection will toggle from Φ M Path 2 to Φ M Path 1.) Configure the modulation characteristics (such as deviation, source, rate, and waveform) using the remaining softkeys in the Φ M menu. Then enable Φ M by setting Φ M Off On to On.

To configure a second phase modulation configuration, toggle to Φ M Path 2. Define the modulation characteristics for this second configuration and enable Φ M by setting Φ M Off On to On.

The RF carrier is available at the RF OUTPUT connector when you set RF On/Off to On. Set Mod On/Off to On to modulate the RF carrier with the modulations that you have enabled.

Φ M Path 1 and Φ M Path 2 are summed internally for composite modulation. Either path can be switched to any one of the modulation sources: Int, Ext1, or Ext2. All modulation types can be simultaneously enabled, except FM with Φ M, AM with external burst source, and wideband AM with I/Q. AM, FM, and Φ M can sum simultaneous inputs from any two sources (Int, Ext1, and Ext2). Any given source (Int, Ext1, or Ext2) can only be routed to one activated modulation type.

Default Value: Φ M Path 1

Softkey Location: FM/ Φ M hardkey > FM Φ M softkey Φ M > Φ M Path 1 2

Φ M Rate

Use this softkey to change the internal modulation frequency for the Φ M Path 1 and Φ M Path 2 configurations. To change the value, press the softkey once. The current value for Φ M rate is displayed in the active entry area. To enter a new value, rotate the front panel knob until the desired value is displayed, use the up and down arrow keys, or enter the value using the numeric keypad and press the Hz or kHz terminator softkey. The range of values allowed is 0.1 Hz to 10 kHz. (0.1 Hz to 50 kHz is the range allowed if sinewave is selected as the internal waveform.) The minimum increment allowed is 0.1 Hz. Notice that the new value of Φ M rate applies only to whichever Φ M path configuration you have currently selected.

Default Value: 400 Hz

Softkey Location: FM/ Φ M hardkey > FM/ Φ M softkey Φ M > Φ M Rate

ΦM Source

Pressing this softkey reveals a menu of choices for phase modulation sources. You can choose internally-generated phase modulation or select an externally-applied signal from either the EXT 1 INPUT or EXT 2 INPUT connectors. The internal modulation is always AC-coupled. For the externally-applied signals, you can choose between AC- and DC-coupled modulation. A 1.0 Vpk input is required for calibrated ΦM deviation settings. The EXT 1 LO/HI and EXT 2 LO/HI display annunciators will turn on if the peak input voltage differs from 1.0 Vpk by more than 3%. (The LO/HI annunciators only function for AC-coupled external inputs.)

The internal and external 1 and 2 sources have multiple uses. You can use them for amplitude, frequency, and phase modulation. For burst modulation, you can only use the external 1 source and you must use the external 2 source for pulse modulation. However, any given source can only be routed to one enabled modulation at a time. If, for example, you were using the external 1 source in a frequency modulation configuration for FM Path 1, and then you configured AM Path 2 to also use the external 1 source, the signal generator would turn off FM Path 1 and assign the external 1 source to your AM Path 2 configuration. Notice that for these purposes the external 1 AC-coupled source is the same as the external 1 DC-coupled source and the external 2 AC-coupled source is the same as the external 2 DC-coupled source.

Softkey Location: FM/ΦM hardkey > FM ΦM softkey ΦM > ΦM Source

ΦM Start Rate

Use this softkey to change the starting internal modulation frequency for swept-sine phase modulation. To change the value, press the softkey once. The current value for the ΦM start rate is displayed in the active entry area. To enter a new value, rotate the front panel knob until the desired value is displayed, use the up and down arrow keys, or enter the value using the numeric keypad and press the Hz or kHz terminator softkey. The range of values allowed is 0.1 Hz to 50 kHz. The minimum increment allowed is 0.1 Hz.

This softkey is coupled to the ΦM Rate softkey in the initial ΦM Menu and the ΦM Tone 1 Rate softkey in the ΦM Dual-Sine Menu. Any value set for ΦM Start Rate is reflected in the ΦM Rate and ΦM Tone 1 Rate softkeys. Conversely, if you change the value for either the ΦM Rate softkey or the ΦM Tone 1 Rate softkey, the value for ΦM Start Rate is changed to match.

Default Value: 400.0 Hz

Softkey Location: FM/ΦM hardkey > FM ΦM softkey ΦM > ΦM Waveform > Swept-Sine > ΦM Start Rate

Φ M Stop Rate

Use this softkey to change the ending internal modulation frequency for swept-sine phase modulation. To change the value, press the softkey once. The current value for the Φ M stop rate is displayed in the active entry area. To enter a new value, rotate the front panel knob until the desired value is displayed, use the up and down arrow keys, or enter the value using the numeric keypad and press the Hz or kHz terminator softkey. The range of values allowed is 0.1 Hz to 50 kHz. The minimum increment allowed is 0.1 Hz.

This softkey is coupled to the Φ M Tone 2 Rate softkey in the Φ M Dual-Sine Menu. Any value set for Φ M Stop Rate is reflected in the Φ M Tone 2 Rate softkey. Conversely, if you change the value for the Φ M Tone 2 Rate softkey, the value for Φ M Stop Rate is changed to match.

Default Value: 400.0 Hz

Softkey Location: FM/ Φ M hardkey > FM Φ M softkey Φ M > Φ M Waveform > Swept-Sine > Φ M Stop Rate

Φ M Sweep Time

Press this softkey to set the sweep time for swept-sine phase modulation. The signal generator will vary the Φ M rate from the specified start rate to the stop rate in the time set with this softkey. Enter the desired sweep time using the up and down arrow keys, the front panel knob, or enter a value using the numeric keypad and press the sec or msec terminator softkey. The range of values allowed is 1 ms through 65.535 s. The minimum increment allowed is 1 ms.

Default Value: 100.0 msec

Softkey Location: FM/ Φ M hardkey > FM Φ M softkey Φ M > Φ M Waveform > Swept-Sine > Φ M Sweep Time

Φ M Sweep Trigger

Pressing this softkey reveals a menu of choices for triggering swept-sine phase modulation. You can choose triggering that occurs immediately, triggering that is supplied by the GPIB, triggering on either the positive or negative edge of a signal supplied to the TRIGGER IN connector, or triggering by the front panel Trigger key.

Default Value: Immediate

Softkey Location: FM/ Φ M hardkey > FM Φ M softkey Φ M > Φ M Waveform > Swept-Sine > Φ M Sweep Trigger

Φ M Tone 1 Rate

Press this softkey to set the internal modulation frequency for the Φ M tone 1. Enter the desired rate using the up and down arrow keys, the front panel knob, or enter a value using the numeric keypad and press the kHz or Hz terminator softkey. The range of values allowed is 0.1 Hz through 50 kHz. The minimum increment allowed is 0.1 Hz.

This softkey is coupled to the Φ M Rate softkey in the initial Φ M Menu and the Φ M Start Rate softkey in the Φ M Swept-Sine Menu. Any value set for Φ M Tone 1 Rate is reflected in the Φ M Rate and Φ M Start Rate softkeys. Conversely, if you change the value for either the Φ M Rate softkey or the Φ M Start Rate softkey, the value for Φ M Tone 1 Rate is changed to match.

Default Value: 400.0 Hz

Softkey Location: FM/ Φ M hardkey > FM Φ M softkey Φ M > Φ M Waveform > Dual-Sine > Φ M Tone 1 Rate

Φ M Tone 2 Ampl Percent Of Peak

Press this softkey to set the amplitude of the alternate frequency/rate as a percent of the peak LF analog modulation amplitude. The primary frequency/rate will make up the remaining amplitude. This softkey is for use with dual-sine modulation only.

For example, if the Tone 2 amplitude is 0%, then there would be no amplitude for Tone 2; all of the signal strength would be present in Tone 1. If Φ M Tone 2 Ampl Percent Of Peak is set to 50%, then Tone 2 and Tone 1 would have equal amplitudes, or half of the amplitude of both tones combined.

Default Value: 50.0%

Softkey Location: FM/ Φ M hardkey > FM Φ M softkey Φ M > Φ M Waveform > Dual-Sine > Φ M Tone 2 Ampl Percent Of Peak

Φ M Tone 2 Rate

Press this softkey to set the internal modulation frequency for the Φ M tone 2. Enter the desired rate using the up and down arrow keys, the front panel knob, or enter a value using the numeric keypad and press the kHz or Hz terminator softkey. The range of values allowed is 0.1 Hz through 50 kHz. The minimum increment allowed is 0.1 Hz.

This softkey is coupled to the Φ M Stop Rate softkey in the Φ M Swept-Sine Menu. Any value set for Φ M Tone 2 Rate is reflected in the Φ M Stop Rate softkey. Conversely, if you change the value for the Φ M Stop Rate softkey, the value for Φ M Tone 2 Rate is changed to match.

Default Value: 400.0 Hz

Softkey Location: FM/ Φ M hardkey > FM Φ M softkey Φ M > Φ M Waveform > Dual-Sine > Φ M Tone 2 Rate

Φ M Waveform

Pressing this softkey reveals a menu of Φ M waveform choices for your Φ M Path 1 and Φ M Path 2 configurations. Select from sine, triangle, square, ramp, noise, dual-sine, and swept-sine waveforms. Notice that your waveform selection applies only to whichever Φ M path configuration you have currently selected.

Default Value: Sine

Softkey Location: **FM/ Φ M hardkey > FM Φ M softkey Φ M > Φ M Waveform**

Bus

This softkey is one of the choices in the Φ M Sweep Trigger menu. With **Bus** selected, you use the GPIB to trigger single sweeps of swept-sine phase modulation.

Softkey Location: **FM/ Φ M hardkey > FM Φ M softkey Φ M > Φ M Waveform > Swept-Sine > Φ M Sweep Trigger > Bus**

DCFM/DC Φ M Cal

Pressing this softkey initiates a DCFM calibration. This calibration eliminates the offset in DC phase modulation so that the carrier phase remains the same with no modulation applied. External, DC-coupled Φ M must be active when this command is executed.

Softkey Location: **FM/ Φ M hardkey > FM Φ M softkey Φ M > DCFM/DC Φ M Cal**

Dual-Sine

Pressing this softkey reveals a menu of choices for setting the dual-sine phase modulation parameters. In this menu you can set the Φ M rates for two separate tones. In addition you can set a ratio of the tone 2 Φ M deviation to the tone 1 Φ M deviation.

Softkey Location: **FM/ Φ M hardkey > FM Φ M softkey Φ M > Φ M Waveform > Dual-Sine**

Ext

This softkey is one of the choices in the Φ M Sweep Trigger menu. Choosing **Ext** allows you to trigger swept-sine phase modulation using a signal applied to the TRIGGER IN rear panel connector. Set the polarity of the trigger signal using the **Trigger In Polarity Neg Pos** softkey.

Softkey Location: **FM/ Φ M hardkey > FM Φ M softkey Φ M > Φ M Waveform > Swept-Sine > Φ M Sweep Trigger > Ext**

Ext 1 AC-Coupled

This softkey lets you input an external, AC-coupled, phase modulation signal to the EXT 1 INPUT connector. The modulation signal is tested for voltage and a display annunciator will report a high or low condition if the voltage is $> \pm 3\%$ of 1 Vpk.

The external 1 input has multiple uses but can be used for only one modulation at a time. If, for example, you were using the external 1 input in an amplitude modulation configuration for **AM Path 1**, and then you configured **ΦM Path 2** to also use the external 1 input, the signal generator would turn off **AM Path 1** and assign the external 1 input to your **ΦM Path 2** configuration. For the purposes of this discussion, the external 1 AC-coupled input is the same as the external 1 DC-coupled source.

Softkey Location: **FM/ΦM** hardkey > **FM ΦM** softkey **ΦM** > **ΦM Source** > **Ext 1 AC-Coupled**

Ext 1 DC-Coupled

This softkey lets you input an external, DC-coupled, phase modulation signal to the EXT 1 INPUT connector.

The external 1 input has multiple uses but can be used for only one modulation at a time. If, for example, you were using the external 1 input in an amplitude modulation configuration for **AM Path 1**, and then you configured **ΦM Path 2** to also use the external 1 input, the signal generator would turn off **AM Path 1** and assign the external 1 input to your **ΦM Path 2** configuration. For the purposes of this discussion, the external 1 AC-coupled input is the same as the external 1 DC-coupled source.

Softkey Location: **FM/ΦM** hardkey > **FM ΦM** softkey **ΦM** > **ΦM Source** > **Ext 1 DC-Coupled**

Ext 2 AC-Coupled

This softkey lets you input an external, AC-coupled, phase modulation signal to the EXT 2 INPUT connector. The modulation signal is tested for voltage and a display annunciator will report a high or low condition if the voltage is $> \pm 3\%$ of 1 Vpk.

The external 2 input has multiple uses but can be used for only one modulation at a time. If, for example, you were using the external 2 input in an amplitude modulation configuration for **AM Path 1**, and then you configured **ΦM Path 2** to also use the external 2 input, the signal generator would turn off **AM Path 1** and assign the external 2 input to your **ΦM Path 2** configuration. For the purposes of this discussion, the external 2 AC-coupled input is the same as the external 2 DC-coupled source.

Softkey Location: **FM/ΦM** hardkey > **FM ΦM** softkey **ΦM** > **ΦM Source** > **Ext 2 AC-Coupled**

Ext 2 DC-Coupled

This softkey lets you input an external, DC-coupled, phase modulation signal to the EXT 2 INPUT connector.

The external 2 input has multiple uses but can be used for only one modulation at a time. If, for example, you were using the external 2 input in an amplitude modulation configuration for **AM Path 1**, and then you configured **ΦM Path 2** to also use the external 2 input, the signal generator would turn off **AM Path 1** and assign the external 2 input to your **ΦM Path 2** configuration. For the purposes of this discussion, the external 2 AC-coupled input is the same as the external 2 DC-coupled source.

Softkey Location: **FM/ΦM** hardkey > **FM ΦM** softkey **ΦM** > **ΦM Source** > **Ext 2 DC-Coupled**

FM ΦM Normal High BW

This softkey toggles between the menus for FM, normal ΦM, and wideband ΦM. Normal ΦM lets you set the phase deviation as high as $N \times 90$ radians with a 3 dB bandwidth of 100 kHz. Wideband ΦM provides increased bandwidth while restricting the maximum deviation to deviation settings up to $\pi/2$ radians (90°). The modulation bandwidth is typically 6 MHz. For deviation settings between $\pi/2$ and 2π radians (360°), the modulation bandwidth is typically 1.5 MHz. (These increased bandwidths are only available using **ΦM Path 1**. **ΦM Path 2** is limited to 1 MHz.)

Default Value: FM

Softkey Location: **FM/ΦM** hardkey > **FM ΦM** softkey once for normal bandwidth or twice for high bandwidth

Immediate

This softkey is one of the choices in the Φ M Sweep Trigger menu. Choosing **Immediate** immediately triggers swept-sine phase modulation in a continuous mode. To stop the sweep, choose a different trigger such as **Ext**, or set the waveform to something other than **Swept-Sine**.

Softkey Location: **FM/ Φ M hardkey > FM Φ M softkey Φ M > Φ M Waveform > Swept-Sine > Φ M Sweep Trigger > Immediate**

Internal

This softkey lets you internally generate an AC-coupled, phase modulation signal.

The internal source has multiple uses but can be used for only one modulation at a time. If, for example, you were using the internal source in an amplitude modulation configuration for **AM Path 1**, and then you configured **Φ M Path 2** to also use the internal source, the signal generator would turn off **AM Path 1** and assign the internal source to your **Φ M Path 2** configuration.

Softkey Location: **FM/ Φ M hardkey > FM Φ M softkey Φ M > Φ M Source > Internal**

Noise

This softkey lets you specify noise as the phase modulation waveform for the **Φ M Path 1** and **Φ M Path 2** configurations. Notice that the selected waveform applies only to whichever Φ M path configuration you have currently selected.

Softkey Location: **FM/ Φ M hardkey > FM Φ M softkey Φ M > Φ M Waveform > Noise**

Sine

This softkey lets you specify sine as the phase modulation waveform for the **Φ M Path 1** and **Φ M Path 2** configurations. Notice that the selected waveform applies only to whichever Φ M path configuration you have currently selected.

Softkey Location: **FM/ Φ M hardkey > FM Φ M softkey Φ M > Φ M Waveform > Sine**

Square

This softkey lets you to specify square as the phase modulation waveform for the Φ M Path 1 and Φ M Path 2 configurations. Notice that the selected waveform applies only to whichever Φ M path configuration you have currently selected.

Softkey Location: FM/ Φ M hardkey > FM Φ M softkey Φ M > Φ M Waveform > Square

Swept-Sine

Pressing this softkey reveals a menu of choices for setting the swept-sine phase modulation parameters. In this menu you can set the start and stop Φ M rate and the sweep time. You can set the signal generator to a single, externally-triggered sweep on either a negative or positive TTL level or you can choose continuous sweep, triggered immediately. In this menu you can also select either a positive or negative polarity for the TRIGGER OUT signal.

Softkey Location: FM/ Φ M hardkey > FM Φ M softkey Φ M > Φ M Waveform > Swept-Sine

Triangle

Specifies triangle as the frequency modulation waveform for the Φ M Path 1 and Φ M Path 2 configurations. Notice that the selected waveform applies only to whichever Φ M path configuration you have currently selected.

Softkey Location: FM/ Φ M hardkey > FM Φ M softkey Φ M > Φ M Waveform > Triangle

Trigger In Polarity Neg Pos

Toggles between a negative TTL level trigger (0 V) and a positive TTL level trigger (+5 V) for externally triggering swept-sine phase modulation.

This softkey is coupled to the **Trigger In Polarity Neg Pos** softkey for swept-sine AM, FM, and LF Out, and to the **Ext Neg** and **Ext Pos** sweep trigger selections in the Sweep/List Menu. If you set the **Trigger In Polarity Neg Pos** softkey in the Φ M Swept-Sine Menu to **Neg**, the **Trigger In Polarity Neg Pos** softkey is also set to **Neg** for swept-sine AM, FM, and LF Out. And, in addition, if the step or list sweep trigger is set to **Ext Pos**, the trigger selection will automatically be changed to **Ext Neg**. The same softkeys will toggle to **Pos** or to **Ext Pos** if you select **Pos** in the Swept-Sine Φ M Menu.

Conversely, if the **Trigger In Slope Neg Pos** softkey is toggled in the swept-sine AM, FM, or LF Out menus, it will cause the swept-sine Φ M softkey to toggle also. This is also true for the **Ext Neg** and **Ext Pos** step or list sweep trigger selections.

Default Value: Pos

Softkey Location: **FM/ Φ M hardkey > FM Φ M softkey Φ M > Φ M Waveform > Swept-Sine > Φ M Sweep Trigger > Ext > Trigger In Polarity Neg Pos**

Trigger Key

This softkey is one of the choices in the Φ M Sweep Trigger menu. With **Trigger Key** selected, when you press the **Trigger** front panel key you immediately trigger a single sweep of swept-sine phase modulation.

The **Trigger** key has autorepeat capability. Hold it down and you will repeatedly trigger sweeps until you release the key.

Softkey Location: **FM/ Φ M hardkey > FM Φ M softkey Φ M > Φ M Waveform > Swept-Sine > Φ M Sweep Trigger > Trigger Key**

Trigger Out Polarity Neg Pos

This softkey toggles the polarity of the TTL signal that is output at the rear panel TRIGGER OUT connector. When **Trigger Out Polarity Neg Pos** is set to **Pos**, the output signal is asserted high (+5 V) at the start of the swept-sine phase modulation sweep and low (0 V) when the sweep is concluded. Setting **Trigger Out Polarity Neg Pos** to **Neg** reverses the polarity, where a high is 0 V and a low is +5 V.

This softkey is coupled to the **Trigger Out Polarity Neg Pos** softkey in the swept-sine AM, FM, and LF Out menus and the sweep/list menu. When the polarity is toggled for this softkey in any one of these menus, it affects all locations of the softkey.

Default Value: Pos

Softkey Location: **FM/ Φ M hardkey > FM Φ M softkey Φ M > Φ M Waveform > Swept-Sine > Trigger Out Polarity Neg Pos**

Power Switch

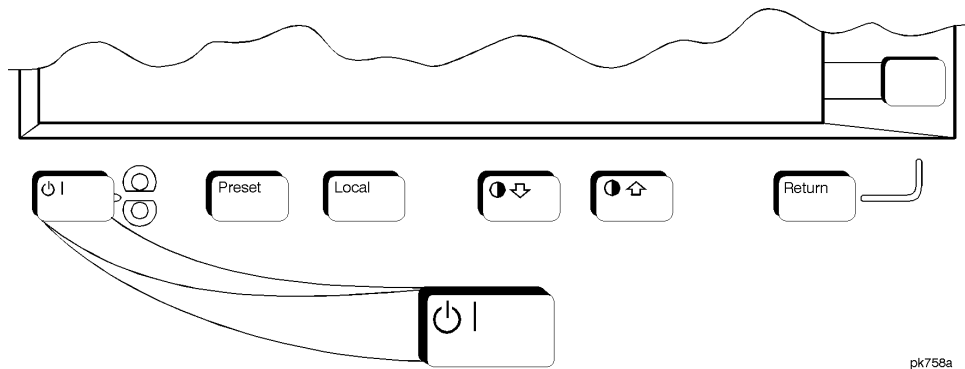

Pressing this front panel key toggles power to the signal generator either on (green LED on) or to standby (yellow LED on). In standby mode, the power switch is off but the instrument is still connected to the mains circuit by way of the power cord. The detachable power cord is the instrument disconnecting device. The front panel power switch, therefore, is not, and should not be used as, a line switch.

CAUTION

Avoid turning off power to the signal generator unless it is quiescent (not currently changing state as a result of front panel operation or remote control).

Preset

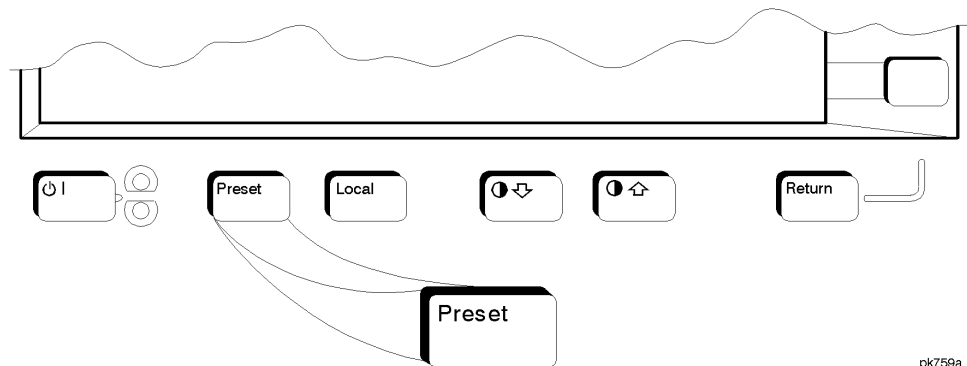

This key sets the signal generator to a known state (either the factory-defined state or a user-defined state).

Use the **Preset Normal User** softkey to set your signal generator to the desired preset conditions (**Normal** = factory, **User** = a user-defined state). For details, refer to the [Preset Normal User](#) softkey description on [page 4-129](#).

Pulse

Pressing the front panel **Pulse** key reveals a menu of softkeys. These softkeys are described in this section in alphabetical order.

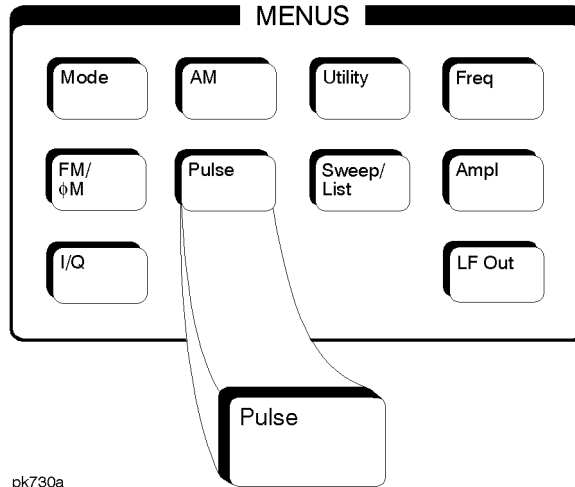

Ext2 DC-Coupled

This softkey lets you input an external, DC-coupled, pulse modulation signal to the EXT 2 INPUT connector.

The external 2 input has multiple uses but can be used for only one modulation at a time. If, for example you were using the external 2 input in a frequency modulation configuration for **FM Path 1**, and then you configured the pulse modulation source to also use the external 2 input, the signal generator would turn off **FM Path 1** and assign the external 2 input to your pulse configuration.

Softkey Location: **Pulse > Pulse Source > Ext2 DC-Coupled**

Fast Pulse Off On

This softkey enables fast pulse modulation from an external, TTL-compatible pulse source via the PULSE IN BNC connector. Notice, however, that although you can enable the fast pulse modulation state with this softkey, the RF carrier is modulated by the pulse signal only when you have also set **Mod On/Off** to **On**. Whenever fast pulse modulation is enabled, the **PULSE** annunciator is turned on in the display.

Default Value: Off

Softkey Location: **Pulse > Fast Pulse Off On**

Internal Pulse

This softkey lets you internally generate rectangular pulse modulation. Configure the pulse modulation using the **Pulse Period** and **Pulse Width** softkeys. For additional specifications, refer to the technical specifications document.

The internal source has multiple uses but can be used for only one modulation at a time. If, for example you were using the internal source in a frequency modulation configuration for **FM Path 1**, and then you configured the pulse modulation source to also use the internal source, the signal generator would turn off **FM Path 1** and assign the internal source to your pulse configuration.

Softkey Location: **Pulse > Pulse Source > Internal Pulse**

Internal Square

This softkey lets you internally generate squarewave pulse modulation. The duty cycle is set at 50% and you can set the pulse rate from 0.1 Hz to 50 kHz. For additional specifications, refer to the technical specifications document.

The internal source has multiple uses but can be used for only one modulation at a time. If, for example you were using the internal source in a frequency modulation configuration for **FM Path 1**, and then you configured the pulse modulation source to also use the internal source, the signal generator would turn off **FM Path 1** and assign the internal source to your pulse configuration.

Softkey Location: **Pulse > Pulse Source > Internal Square**

Pulse Off On

This softkey enables the pulse modulation for whichever pulse source you have selected. Notice, however, that although you can enable the pulse modulation state with this softkey, the RF carrier is modulated by the enabled modulation only when you have also set **Mod On/Off** to **On**. Whenever pulse modulation is enabled, the **PULSE** annunciator is turned on in the display.

Default Value: Off

Softkey Location: **Pulse > Pulse Off On**

Pulse Period

Use this softkey to change the pulse period for internal pulse modulation. To change the period, press the softkey once. The current value for pulse period is displayed in the active entry area. To enter a new value, rotate the front panel knob until the desired value is displayed, use the up and down arrow keys, or enter the value using the numeric keypad and press the msec or μ sec terminator softkey. The range of values allowed is 16 μ s to 30 s. If the value for pulse period is less than the value for pulse width, pulse width is changed to the same value as pulse period. Notice that pulse period applies only to internal pulse modulation; when external pulse modulation or internal square pulse modulation is selected, this softkey is disabled.

Default Value: 80 μ s

Softkey Location: **Pulse** > **Pulse Period**

Pulse Rate

Use this softkey to change the pulse rate for internal square pulse modulation. To change the rate, press the softkey once. The current value for pulse rate is displayed in the active entry area. To enter a new value, rotate the front panel knob until the desired value is displayed, use the up and down arrow keys, or enter the value using the numeric keypad and press the Hz or kHz terminator softkey. The range of values allowed is 0.1 Hz to 50 kHz. Notice that the new value of pulse rate applies only to internal square pulse modulation; when external pulse modulation or internal pulse modulation is selected, this softkey is disabled.

Default Value: 400 Hz

Softkey Location: **Pulse** > **Pulse Rate**

Pulse Source

Pressing this softkey reveals a menu of choices for pulse modulation sources. You can choose internally-generated pulse modulation, internally-generated square pulse modulation, or select an externally-applied, DC-coupled signal from the EXT 2 INPUT connector.

The internal and external 2 sources have multiple uses. However, you can use each source for only one modulation type at a time. If, for example, you were using the external 2 source in a frequency modulation configuration for **FM Path 1**, and then you configured the pulse modulation source to also use the external 2 source, the signal generator would turn off **FM Path 1** and assign the external 2 source to your pulse configuration.

Default Value: Internal Pulse

Softkey Location: **Pulse** > **Pulse Source**

Pulse Width

Use this softkey to change the pulse width for internal pulse modulation. To change the pulse width, press the softkey once. The current value for pulse width is displayed in the active entry area. To enter a new value, rotate the front panel knob until the desired value is displayed, use the up and down arrow keys, or enter the value using the numeric keypad and press the μsec or msec terminator softkey. The range of values allowed is 8 μs to 30 s. Notice that the new value of pulse width applies only to internal pulse modulation; when external pulse modulation or internal square pulse modulation is selected, this softkey is disabled.

Default Value: 40 μs

Softkey Location: **Pulse > Pulse Source > Internal Square > Pulse Width**

Recall

Pressing the front panel **Recall** key reveals a menu of softkeys. These softkeys are described in this section in alphabetical order.

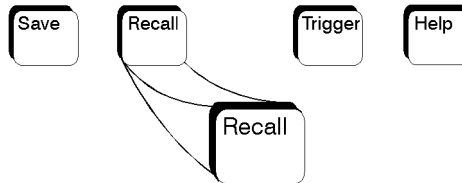

pk752a

Delete All Regs in Seq [n]

Press this softkey to delete the data saved in all of the registers of the selected sequence. Do not press this softkey until you have selected the correct sequence using the softkey. For example, if you want to delete the data in all of the registers that are saved in sequence 4, press **Select Seq**. The currently selected sequence is displayed in the active entry area. Change the number to 4 using the up and down arrow keys, the front panel knob, or enter a 4 using the numeric keypad and press the **Enter** terminator softkey. Sequence 4 is now displayed in all softkeys which specify a sequence in this menu. Now press **Delete All Regs in Seq [4]** and the data in all of the registers stored in sequence 4 will be deleted. Be certain that you want to delete this data; you cannot recover it once deleted.

NOTE

This softkey has exactly the same function as the softkey with the identical name in the front panel **Save** key menu.

Softkey Location: **Recall > Delete All Regs in Seq[n]**

Delete All Sequences

Press this softkey to delete all of the data in all saved registers of all sequences. Be certain that you want to delete the data; you cannot recover it once deleted.

NOTE

This softkey has exactly the same function as the softkey with the identical name in the front panel **Save** key menu.

Softkey Location: **Recall > Delete All Sequences**

Delete Seq[n] Reg[nn]

Press this softkey to delete the contents of a specified register in a specified sequence. Do not press this softkey until you have selected the correct sequence and register using the **Select Seq** and **Recall Reg** softkeys. For example, if you want to delete the contents of register 5 in sequence 4, press **Select Seq**. The currently selected sequence is displayed in the active entry area. Change the number to 4 using the up and down arrow keys, the front panel knob, or enter a 4 using the numeric keypad and press the **Enter** terminator softkey. Sequence 4 is now displayed in all softkeys which specify a sequence in this menu. Now select register 5. (Remember, you must first have saved an instrument state to this register in sequence 4.) Press **Recall Reg**. The recall register number becomes the active function. Enter the number 5 using the numeric keypad and press the **Enter** terminator softkey. The instrument state is restored from this register and register 5 is now displayed in all softkeys which specify a register number in this menu. Now press **Delete Seq [4] Reg[05]** and register 5, stored in sequence 4, will be deleted. The instrument state that you had recalled from this register remains, however, until you change it. If you deleted this register in error, you can immediately resave it using the **Save Seq[n] Reg[n]** softkey in the **Save** menu.

NOTE

This softkey has exactly the same function as the softkey with the identical name in the front panel **Save** key menu.

Softkey Location: **Recall** > **Delete Seq[n] Reg[nn]**

Recall Reg

Press this softkey to recall an instrument state from a saved register. Recalling a register also selects that register number for all softkeys which specify a register number in this menu. For example, if you want to select register 5, press **Recall Reg**. (Remember, you must first have saved an instrument state to this register in the current sequence identified by the **Select Seq** softkey. If there is nothing saved, you cannot recall it.) The recall register number becomes the active function. Enter the number 5 using the numeric keypad and press the **Enter** terminator softkey. The instrument state is restored from this register and register 5 is now displayed in all softkeys which specify a register in this menu. You can also use the front panel knob and the up and down arrow keys to scroll through all saved registers for the selected sequence, recalling each instrument state.

Softkey Location: **Recall** > **Recall Reg**

Select Seq

Press this softkey to choose a sequence for all softkeys which specify a sequence in this menu. For example, if you want to select sequence 4, press **Select Seq**. The currently selected sequence is displayed in the active entry area. Change the number to 4 using the up and down arrow keys, the front panel knob, or enter a 4 using the numeric keypad and press the **Enter** terminator softkey. Sequence 4 is now displayed in all softkeys which specify a sequence in this menu. There are 100 registers available (0 through 99) in each of 10 (0 through 9) sequences. You can use these registers in any combination so long as the total number of registers used does not exceed 50.

NOTE

The actual number of states that can be saved may be less if the user file system has non-instrument state files stored such as sweep/list sequences or binary files.

Softkey Location: **Recall** > **Select Seq**

Return

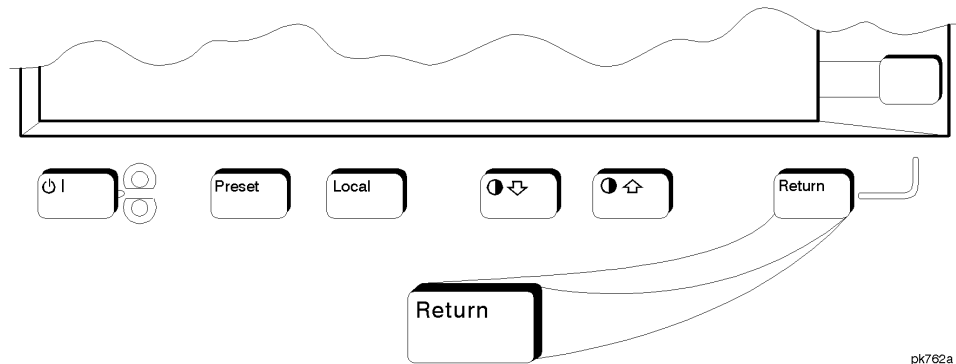

This front panel hardkey moves you from your current softkey menu to the softkey menu that precedes it. For example, press the **LF Out** front panel hardkey. The **LF Out** menu is displayed. Now press the **LF Out Source** softkey. (The arrow indicates that pressing this softkey will display another menu.) You should now see the **LF Out Source** menu. Press **Return**, and you are moved back to the **LF Out** menu.

When you are at the top level of the menus the **Return** key has no function.

The **Return** key has autorepeat capability. Hold it down and you are moved repeatedly back through the menus until you either release the key or you reach the top level of the menus.

While you are entering data with the numeric keypad, pressing the **Return** key cancels the data input and leaves the original value unchanged.

RF On/Off

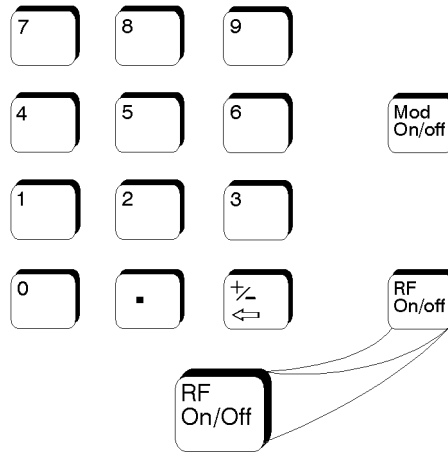

pk757a

This front panel hardkey toggles the RF signal on and off at the RF OUTPUT connector. Although you can configure and engage various modulations, no signal is available at the RF OUTPUT connector until RF On/Off is set to On. An annunciator is always turned on in the display to indicate whether RF is turned on or off.

Default Value: RF Off

Save

Pressing the front panel **Save** key reveals a menu of softkeys. These softkeys are described in this section in alphabetical order.

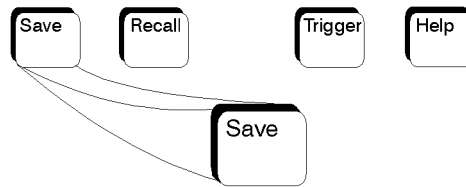

pk751a

When you press the **Save** key, the text area of the display shows the registers in use and any comments associated with the registers for the last sequence accessed. The display is updated whenever you make any changes to the registers or to the comments.

Add Comment To Seq[n] Reg[nn]

Press this softkey to add a comment that is associated with a register in use. The register number is listed in the text area of the display and the comment is shown immediately following the register. You can use the comment line, for example, to identify the instrument state saved in a register.

The comment line can consist of up to 55 alpha-numeric characters and special characters. To add or change a comment, the following editing capabilities are provided:

- The **Editing Mode Insert Replace** softkey in the Editing Keys menu toggles the editing mode from inserting text to replacing text. Insertion mode causes text to be entered in the position directly to the right of the cursor. Replacement mode causes the text to be entered in the position held by the cursor (replacing any existing text in that position).
- The **Clear Text** softkey in the Editing Keys menu deletes all of the existing text in the active entry area.
- Use the left and right arrow keys to position the cursor. Use the front panel knob, up and down arrow keys, or the direct editing softkeys, to enter an alphabetic character, numeral, or special character.

When you have entered the comment text, press the **Enter** terminator softkey. If you have changed your mind, press the **Return** hardkey. Once you press **Enter**, the new comment is saved to your selected register and displayed immediately.

Softkey Location: **Save > Add Comment To Seq[n] Reg[nn]**

Clear Text

Press this softkey to delete the comment text in the active entry area. If you want to change the comment text saved with a register, use this softkey to quickly delete the existing text, then use the remaining editing features to enter a new comment.

Softkey Location: **Save > Add Comment To Seq[n] Reg[nn] > Editing Keys > Clear Text**

Delete All Regs in Seq [n]

Press this softkey to delete the data saved in all of the registers of the selected sequence. Do not press this softkey until you have selected the correct sequence using the **Select Seq** softkey. For example, if you want to delete all of the registers that are saved in sequence 4, press **Select Seq**. The currently selected sequence is displayed in the active entry area. Change the number to 4 using the up and down arrow keys, the front panel knob, or enter a 4 using the numeric keypad and press the **Enter** terminator softkey. Sequence 4 is now displayed in all softkeys which specify a sequence in this menu. Now press **Delete All Regs in Seq [4]** and the data in all of the registers stored in sequence 4 will be deleted. Be certain that you want to delete the data; you cannot recover it once deleted.

NOTE

This softkey has exactly the same function as the softkey with the identical name in the front panel **Recall** key menu.

Softkey Location: **Save > Delete All Regs in Seq [n]**

Delete All Sequences

Press this softkey to delete all of the data in all saved registers of all sequences. Be certain that you want to delete the data; you cannot recover it once deleted.

NOTE

This softkey has exactly the same function as the softkey with the identical name in the front panel **Recall** key menu.

Softkey Location: **Save > Delete All Sequences**

Delete Seq[n] Reg[nn]

Press this softkey to delete the contents of a specified register in a specified sequence. Do not press this softkey until you have selected the correct sequence and register using the **Select Seq** and **Select Reg** softkeys. For example, if you want to delete register 5 in sequence 4, press **Select Seq**. The currently selected sequence is displayed in the active entry area. Change the number to 4 using the up and down arrow keys, the front panel knob, or enter a 4 using the numeric keypad and press the **Enter** terminator softkey. Sequence 4 is now displayed in all softkeys which specify a sequence number in this menu. Now, to select register 5, press **Select Reg**. The currently selected register is displayed in the active entry area. Change the number to 5 in the same way that you changed the sequence number. Register 5 is now displayed in all softkeys which specify a register number in this menu. Now press **Delete Seq [4] Reg[05]** and register 5, stored in sequence 4, will be deleted. Be certain that you want to delete the data; you cannot recover the data once deleted.

NOTE

This softkey has exactly the same function as the softkey with the identical name in the front panel **Recall** key menu.

Softkey Location: **Save > Delete Seq[n] Reg[nn]**

Editing Keys

Pressing this softkey reveals a menu of choices for creating and editing the comment text for the selected register. In this menu you can delete the existing text in the active entry area (either the existing comment, or comment text that you have subsequently entered), and you can toggle the editing mode from inserting text to replacing text.

Softkey Location: **Save > Add Comment To Seq[n] Reg[nn] > Editing Keys**

Editing Mode Insert Replace

Press this softkey to toggle the editing mode from inserting text to replacing text. Insertion mode causes text to be entered in the position directly to the right of the cursor. Replacement mode causes the text to be entered in the position held by the cursor (replacing any existing text in that position).

Softkey Location: **Save > Add Comment To Seq[n] Reg[nn] > Editing Keys > Editing Mode Insert Replace**

Save Seq[n] Reg[nn]

Press this softkey to save the current instrument state in the specified register and sequence. The instrument state includes all of your setup selections except list and step sweep data and functions which are identified in this manual as persistent states. Do not press this softkey until you have specified the correct sequence and register using the **Select Seq** and **Select Reg** softkeys. For example, if you want to save to register 5 in sequence 4, press **Select Seq**. The currently selected sequence is displayed in the active entry area. Change the number to 4 using the up and down arrow keys, the front panel knob, or enter a 4 using the numeric keypad and press the **Enter** terminator softkey. Sequence 4 is now displayed in all softkeys which specify a sequence in this menu. Now, to select register 5, press **Select Reg**. The currently selected register is displayed in the active entry area. Change the number to 5 in the same way that you changed the sequence number. Register 5 is now displayed in all softkeys which specify a register in this menu. Now press **Save Seq [4] Reg[05]** and the current instrument state will be stored in register 5 of sequence 4. There are 100 registers available (0 through 99) in each of 10 (0 through 9) sequences. You can use these registers in any combination so long as the total number of registers used does not exceed 100.

Softkey Location: **Save > Save Seq[n] Reg[nn]**

Select Reg

Press this softkey to choose a register for all softkeys which specify a register in this menu. For example, if you want to select register 5, press **Select Reg**. The currently selected register is displayed in the active entry area. Change the number to 5 using the up and down arrow keys, the front panel knob, or enter a 5 using the numeric keypad and press the **Select Reg** terminator softkey. Register 5 is now displayed in all softkeys which specify a register in this menu.

You can also use this softkey to select a register and save the current instrument state to that register. For example, if you want to select and save to register 6, press **Select Reg**. The currently selected register is displayed in the active entry area. Change the number to 6 using the numeric keypad and press the **Save Reg** terminator softkey. Register 6 is now displayed in all softkeys which specify a register in this menu and the current instrument state has been saved to register 6.

There are 100 registers available (0 through 99) in each of 10 (0 through 9) sequences. You can use these registers in any combination so long as the total number of registers used does not exceed 100.

Softkey Location: **Save > Select Reg**

Select Seq

Press this softkey to choose a sequence for all softkeys which specify a sequence in this menu. For example, if you want to select sequence 4, press **Select Seq**. The currently selected sequence is displayed in the active entry area. Change the number to 4 using the up and down arrow keys, the front panel knob, or enter a 4 using the numeric keypad and press the **Enter** terminator softkey. Sequence 4 is now displayed in all softkeys which specify a sequence in this menu.

There are 100 registers available (0 through 99) in each of 10 (0 through 9) sequences. You can use these registers in any combination so long as the total number of registers used does not exceed 100.

NOTE

The actual number of states that can be saved may be less if the user file system has non-instrument state files stored such as sweep/list sequences or binary files.

Softkey Location: **Save > Select Seq**

Sweep/List

Pressing the front panel **Sweep/List** key reveals a menu of softkeys. Using these softkeys you can define a series of points containing frequency, amplitude, and dwell time information for the signal generator to sweep. The softkeys are described in this section in alphabetical order.

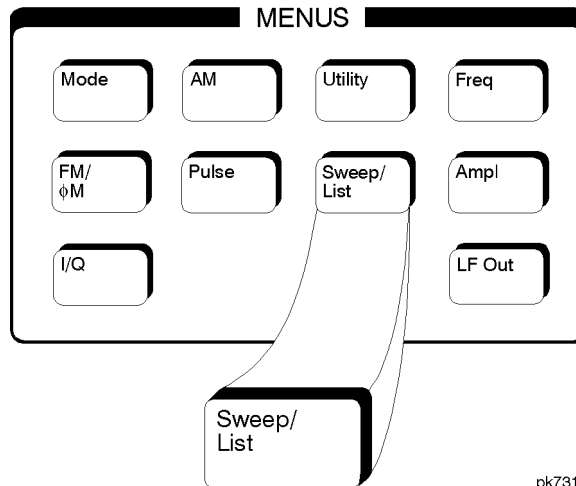

pk731a

Points

Press this softkey to define the number of points in a step sweep. To enter the number of points in the sweep, press **# Points**. The number of step sweep points becomes the active function and the current value is shown in the active entry area. To enter a new value, rotate the front panel knob until the desired value is displayed, use the up and down arrow keys, or enter the value using the numeric keypad and press the **Enter** terminator softkey. A step sweep must always have a minimum of 2 points and can be configured to have as many as 401 points.

Default Value: 2

Softkey Location: **Sweep/List > Configure Step Sweep > # Points**

Ampl

Press this softkey to set the signal generator to sweep amplitude data only. The frequency is set at a constant value determined by the **Frequency** front panel key. You can define a sweep containing both amplitude and frequency information and still choose to sweep amplitude only.

Softkey Location: **Sweep/List > Sweep > Ampl**

Ampl Start

Sets the amplitude of the first point in the sweep. You can set the value anywhere in the range of the signal generator's specified output power. Press **Ampl Start** and amplitude becomes the active function for the first point in the sweep. To enter the value, rotate the front panel knob until the desired value is displayed, use the up and down arrow keys, or enter the value using the numeric keypad and press the **dBm**, **dBuV**, **dBuVemf**, **mV**, **uV**, **mVemf**, or **uVemf** terminator softkey.

Default Value: -135 dBm

Softkey Location: **Sweep/List > Configure Step Sweep > Ampl Start**

Ampl Stop

Sets the amplitude of the last point in the sweep. You can set the value anywhere in the range of the signal generator's specified output power. Press **Ampl Stop** and amplitude becomes the active function for the last point in the sweep. To enter the value, rotate the front panel knob until the desired value is displayed, use the up and down arrow keys, or enter the value using the numeric keypad and press the **dBm**, **dBuV**, **dBuVemf**, **mV**, **uV**, **mVemf**, or **uVemf** terminator softkey.

Default Value: -135 dBm

Softkey Location: **Sweep/List > Configure Step Sweep > Ampl Stop**

Bus

This softkey is one of the choices in both the Sweep Trigger menu and the Point Trigger menu. Press either the **Sweep Trigger** softkey or the **Point Trigger** softkey to view these menus. Choosing **Bus** in the Sweep Trigger menu allows you to trigger a list or step sweep using the GPIB. Choosing **Bus** in the Point Trigger menu allows you to trigger a sweep point-by-point using the GPIB via *TRG or the GET line (Group Execute Trigger).

Softkey Location: **Sweep/List > Sweep Trigger > Bus**

Or: **Sweep/List > Point Trigger > Bus**

Configure List Sweep

Reveals a menu of softkeys for defining a list sweep. In this menu you can insert and delete points in a sweep. Each point can contain frequency, amplitude, and dwell time information. The list point information is stored in three binary files: **FREQ_FILE**, **POW_FILE**, and **DWEL_FILE**. These files will survive a preset but not a power cycle. If they are deleted, the signal generator will recreate these files as needed. In this menu you can also edit existing points in the sweep.

Softkey Location: **Sweep/List > Configure List Sweep**

Configure Step Sweep

Pressing this softkey reveals a menu of softkeys for defining a step sweep. In this menu you can set the start and stop frequencies for a sweep, set the start and stop power levels, and you can set the number of points in the sweep with the dwell time at each point.

Softkey Location: **Sweep/List > Configure Step Sweep**

Delete File

Press this softkey to delete a file in the catalog listing. Use the up and down arrow keys until the file you wish to delete is highlighted. Press **Delete File** and then press the **Confirm Delete** softkey. Be certain that you want to delete the file; you cannot recover this sweep data once you press **Confirm Delete**. If you do not want to delete the file, press **Return** instead of **Confirm Delete**.

Softkey Location: **Sweep/List > Configure List Sweep > Load/Store > Delete File**

Delete Item

Press this softkey to delete an item in the displayed list of sweep points. Use the arrow keys until the desired item is highlighted. Then press **Delete Item** to eliminate this item from the sweep list. Be certain that you want to delete this item; you cannot recover it once you have deleted it. If the last item in a list is deleted, it is replaced by the default value.

Softkey Location: **Sweep/List > Configure List Sweep > Delete Item**

Delete Row

Press this softkey to delete a selected row in the sweep list. Use the up and down arrow keys until any item is selected in the row you wish to delete. Press **Delete Row** and the entire row is deleted. Be certain that you want to delete the row; you cannot recover this sweep data once you press **Delete Row**. If the last row in a list is deleted, it is replaced by the default value.

Softkey Location: **Sweep/List > Configure List Sweep > Delete Row**

Dwell Type List Step

Press this softkey to toggle the dwell time for the list sweep points between the values defined in the list sweep and the value set for step sweep. Choose **List** to sweep with dwell times that you have defined in the list sweep. Choose **Step** and you will sweep each point in the list with a dwell time set by the **Step Dwell** softkey in the Configure Step Sweep menu. When you are sweeping using the step sweep dwell time, the list sweep dwell time values are grayed out to indicate that they are not being used.

Default Value: List

Softkey Location: Sweep/List > Configure List Sweep > Dwell Type List Step

Edit Item

Press this softkey to change an item in the displayed list of sweep points. Use the arrow keys or the front panel knob until the correct item is highlighted. Press **Edit Item** and the item is displayed in the active entry area. Change the value using the up and down arrow keys, or the front panel knob and press the **Enter** terminator softkey. Or enter a new value using the numeric keypad and then press a units terminator softkey.

A short cut for editing, Auto Edit, is also available. Highlight the item you want to edit. Enter a new value *using the numeric keys*; editing immediately starts for the highlighted item. Press the **Enter** terminator softkey. The new value is stored and the next item is highlighted.

Softkey Location: Sweep/List > Configure List Sweep > Edit Item

Ext

This softkey is one of the choices in both the Sweep Trigger menu and the Point Trigger menu. Press either the **Sweep Trigger** softkey or the **Point Trigger** softkey to view this key. Choosing **Ext** allows you to trigger a sweep point-by-point on either the negative or positive edge of a signal applied to the TRIGGER IN rear panel connector. Set the polarity of the trigger signal using the **Trigger In Polarity Neg Pos** softkey.

Softkey Location: Sweep/List > Sweep Trigger > Ext

Or: Sweep/List > Point Trigger > Ext

Freq

Press this softkey to set the signal generator to sweep frequency data only. The amplitude is set at a constant level determined by the **Amplitude** front panel key. You can define a sweep containing both amplitude and frequency information and still choose to sweep frequency only.

Softkey Location: Sweep/List > Sweep > Freq

Freq&Ampl

Press this softkey to set the signal generator to sweep both frequency and amplitude data. Both the frequency and the amplitude lists must have the same number of points or they must have only one point. If a list has only one point, then that point is used for each of the other list's points.

Softkey Location: **Sweep/List > Sweep > Freq&Ampl**

Freq Start

Press this softkey to set the frequency of the first point in the sweep. You can set the value anywhere in the range of the signal generator's specified output frequency. Press **Freq Start** and frequency becomes the active function for the first point in the sweep. To enter the value, rotate the front panel knob until the desired value is displayed, use the up and down arrow keys, or enter the value using the numeric keypad and press the **GHz**, **MHz**, **kHz**, or **Hz** terminator softkey.

Default Value: Maximum specified frequency

Softkey Location: **Sweep/List > Configure Step Sweep > Freq Start**

Freq Stop

Press this softkey to set the frequency of the last point in the sweep. You can set the value anywhere in the range of the signal generator's specified output frequency. Press **Freq Stop** and frequency becomes the active function for the last point in the sweep. To enter the value, rotate the front panel knob until the desired value is displayed, use the up and down arrow keys, or enter the value using the numeric keypad and press the **GHz**, **MHz**, **kHz**, or **Hz** terminator softkey.

Default Value: Maximum specified frequency

Softkey Location: **Sweep/List > Configure Step Sweep > Freq Stop**

Goto Bottom Row

Press this softkey to move the selection bar to the bottom row of list sweep points when you are in the Goto Row menu that is accessed from the Configure List Sweep menu. If you are in the Goto Row menu that is accessed from the Load/Store menu, the selection bar moves to the bottom row of the catalog of list files.

Softkey Location: **Sweep/List > Configure List Sweep > Goto Row > Goto Bottom Row**

Or: **Sweep/List > Configure List Sweep > Load/Store > Goto Row > Goto Bottom Row**

Goto Middle Row

Press this softkey to move the selection bar to the middle row of list sweep points when you are in the Goto Row menu that is accessed from the Configure List Sweep menu. If you are in the Goto Row menu that is accessed from the Load/Store menu, the selection bar moves to the middle row of the catalog of list files.

Softkey Location: **Sweep/List > Configure List Sweep > Goto Row > Goto Middle Row**

Or: **Sweep/List > Configure List Sweep > Load/Store > Goto Row > Goto Middle Row**

Goto Row

Pressing this softkey reveals a menu of softkeys that help you move the selection bar through the rows of list sweep points when you are in the Configure List Sweep menu. If you are in the Load/Store menu, the softkeys help you move the selection bar through the catalog of list files. You can also go to a specific row by rotating the front panel knob, using the up and down arrow keys, or entering the row number with the numeric keypad. Once the desired row number is displayed, press the Enter terminator softkey.

Softkey Location: **Sweep/List > Configure List Sweep > Goto Row**

Or: **Sweep/List > Configure List Sweep > Load/Store > Goto Row**

Goto Top Row

Press this softkey to move the selection bar to the top row of list sweep points when you are in the Goto Row menu that is accessed from the Configure List Sweep menu. If you are in the Goto Row menu that is accessed from the Load/Store menu, the selection bar moves to the top row of the catalog of list files.

Softkey Location: **Sweep/List > Configure List Sweep > Goto Row > Goto Top Row**

Or: **Sweep/List > Configure List Sweep > Load/Store > Goto Row > Goto Top Row**

Immediate

This softkey is one of the choices in both the Sweep Trigger menu and the Point Trigger menu. Press either the **Sweep Trigger** softkey or the **Point Trigger** softkey to view these menus. Choosing **Immediate** in the Sweep Trigger menu immediately triggers the current sweep when you press the **Single Sweep** softkey. When sweep repeat is continuous and **Immediate** is chosen for the sweep trigger, then sweeps are triggered consecutively (a new sweep is triggered as soon as the current sweep ends). Choosing **Immediate** in the Point Trigger menu causes the sweep to pause for the dwell time at each point after the hardware has been set up for that point's frequency and amplitude.

Softkey Location: **Sweep/List > Sweep Trigger > Immediate**

Or: **Sweep/List > Point Trigger > Immediate**

Insert Item

Press this softkey to place a copy of the selected item directly below that item in the sweep list. First use the up and down arrow keys until the item you wish to copy is selected. Press **Insert Item** and an identical copy of the selected item is placed below it.

Softkey Location: **Sweep/List > Configure List Sweep > Insert Item**

Insert Row

Press this softkey to place a copy of the selected row directly below that row in the sweep list. First use the up and down arrow keys until any item is selected in the row you wish to copy. Press **Insert Row** and an identical copy of the selected row is placed below it.

Softkey Location: **Sweep/List > Configure List Sweep > Insert Row**

Load From Selected File

Press this softkey to load the list sweep data from a file into the current sweep list. Use the arrow keys to highlight the desired sweep list file. Press **Load From Selected File** and the list sweep data from the selected file is loaded into the current list sweep. You can only have one list sweep at a time so the existing list sweep data will be lost unless it is first stored to a file. This softkey is inactive unless at least one list sweep data file has been stored to memory.

Softkey Location: **Sweep/List > Configure List Sweep > Load/Store > Load From Selected File**

Load List From Step Sweep

Press this softkey to eliminate the existing sweep list data and replace it with the step sweep data points. You can only have one sweep list at a time so be certain that you wish to delete the existing list. You cannot recover the sweep list data once you press **Load List From Step Sweep**.

Softkey Location: **Sweep/List > Configure List Sweep > Load List From Step Sweep**

Load/Store

Pressing this softkey reveals a menu of choices for storing list sweep data to a file or loading list sweep data from a file into the current sweep list. In this menu you can also delete existing list sweep files.

Softkey Location: **Sweep/List > Configure List Sweep > Load/Store**

Manual Mode Off On

This softkey toggles manual selection of the current sweep point on and off. When **Manual Mode** is **On**, the selected sweep/list point controls the frequency and amplitude according to the sweep type. The current point in the sweep is displayed in the active entry area and also below the **Manual Point** softkey. This softkey is disabled when **Sweep** is set to **Off**.

Default Value: Off

Softkey Location: **Sweep/List > Manual Mode Off On**

Manual Point

Press this softkey to choose a point in the sweep list. When **Manual Mode** is **On**, the selected sweep/list point controls the frequency and amplitude according to the sweep type. The current point number is shown in the active entry area when you press **Manual Point**. The frequency of the point is shown in the frequency area of the display. The amplitude of the point is shown in the amplitude area of the display. You can choose which point to sweep using the up and down arrow keys, the front panel knob, or by entering the point number desired using the numeric keypad and pressing the **Enter** terminator softkey. This softkey is disabled when **Manual Mode Off On** is set to **Off**.

Default Value: 1

Softkey Location: **Sweep/List > Manual Point**

Off

This softkey turns off all sweep functions. The output signal is then set according to the current frequency and amplitude settings defined by the front panel **Frequency** and **Amplitude** keys.

Softkey Location: **Sweep/List > Sweep > Off**

Page Down

Press this softkey to view the next page of list sweep points when you are in the **Goto Row** menu that is accessed from the **Configure List Sweep** menu. If you are in the **Load/Store** menu or the **Goto Row** menu that is accessed from the **Load/Store** menu, you will view the next page of the catalog of list files.

Softkey Location: **Sweep/List > Configure List Sweep > Goto Row > Page Down**

Or: **Sweep/List > Configure List Sweep > Load/Store > Page Down**

Or: **Sweep/List > Configure List Sweep > Load/Store > Goto Row > Page Down**

Page Up

Press this softkey to view the previous page of list sweep points when you are in the **Goto Row** menu that is accessed from the **Configure List Sweep** menu. If you are in the **Load/Store** menu or the **Goto Row** menu that is accessed from the **Load/Store** menu, you will view the previous page of the catalog of list files.

Softkey Location: **Sweep/List > Configure List Sweep > Goto Row > Page Up**

Or: **Sweep/List > Configure List Sweep > Load/Store > Page Up**

Or: **Sweep/List > Configure List Sweep > Load/Store > Goto Row > Page Up**

Point Trigger

Pressing this softkey reveals a menu of choices for triggering a sweep point-by-point. You can choose triggering that occurs after the dwell time for the previous point has passed, triggering that is supplied by the GPIB, triggering on either the positive or negative edge of a signal supplied to the TRIGGER IN connector, or triggering by the front panel **Trigger** key.

Default Value: **Immediate**

Softkey Location: **Sweep/List > Point Trigger**

Preset List

Press this softkey to eliminate the current sweep list and replace it with a new list consisting of the following: one point at the maximum specified frequency, with an amplitude of -135 dBm, and a dwell time of 2 ms. Be certain that you want to delete the current sweep list; you cannot recover the information once you press **Preset List**.

Softkey Location: **Sweep/List** > **Configure List Sweep** > **Preset List**

Single Sweep

Press this softkey to arm the sweep. The **ARMED** annunciator will turn on in the display. The signal generator will begin the sweep as soon as the sweep trigger is received. If you have set the sweep trigger to **Immediate**, a sweep is initiated as soon as you arm the sweep. The sweep sets the power and the frequency to the first point of the sweep while it is not initiated or is waiting for the sweep trigger. This softkey is disabled when **Sweep** is set to **Off**.

Softkey Location: **Sweep/List** > **Single Sweep**

Step Dwell

Press this softkey to set the dwell time for each point of a step sweep. To set the dwell time, press **Step Dwell**. The current dwell time is displayed in the active entry area. Enter the desired dwell time using the up and down arrow keys, the front panel knob, or enter a value using the numeric keypad and press the **sec** or **msec** terminator softkey. The range of values allowed is 1 ms through 60 s in 1 ms increments. Dwell time is used when the point trigger is **Immediate**. The dwell time is the amount of time the sweep is guaranteed to pause after setting the frequency and power for the current sweep/list point.

Softkey Location: **Sweep/List** > **Configure Step Sweep** > **Step Dwell**

Store to File

Press this softkey to store the current list sweep data to a file in internal non-volatile memory. Press **Store To File** and you will automatically enter the editing mode to create a file name.

The file name can consist of up to 23 alpha-numeric and special characters. The following steps show you how to create the following example file name, **FREQ 1453 TO 1465 MHZ**:

NOTE

The following example uses softkeys to enter the file name. You can also use a combination of the front panel knob and the arrow keys to accomplish the same function.

1. Press the softkey labeled **ABCDEFGH**. A menu is revealed containing a softkey for each alphabetic character from A through G.

2. Press the softkey labeled **F**. An **F** is entered as the first character in your file name. Notice that the active entry area now shows `Store to: F`.
3. Enter an **R** in the file name by pressing the **OPQRSTU** softkey and then pressing the **R** softkey. Enter an **E** and a **Q**.
4. Next enter a space by pressing the **& # + -** softkey and then pressing **█**.
5. Enter the value 1453 using the numeric keypad.
6. Enter another space and the letters **TO**.
7. Enter another space and the value 1465.
8. Enter another space and the letters **MHZ**.
9. Now press the **Enter terminator** softkey and the list sweep data is saved with the file name, `FREQ 1453 TO 1465 MHZ`. The characters `@LIST` are automatically appended to the file name as file type identification.

Softkey Location: **Sweep/List > Configure List Sweep > Load/Store > Store To File**

Sweep

Pressing this softkey reveals a menu of choices for determining the sweep parameters. In this menu you can choose to sweep frequency only, amplitude only, or both frequency and amplitude. You can also choose to turn off all sweep functions.

Default Value: Off

Softkey Location: **Sweep/List > Sweep**

Sweep Direction Down Up

This softkey changes the direction of the sweep. Choose **Up** to sweep from the first point in the list to the last point, or from the step sweep start frequency and amplitude to the stop frequency and amplitude. Choose **Down** to reverse the direction of the sweep.

Default Value: Up

Softkey Location: **Sweep/List > Sweep Direction Down Up**

Sweep Repeat Single Cont

Toggles the sweep repetition between single sweep or continuous sweep types. The sweep and point triggers will then trigger the sweep.

Default Value: Single

Softkey Location: **Sweep/List > Sweep Repeat Single Cont**

Sweep Trigger

Reveals a menu of choices for triggering a full sweep. You can choose triggering that occurs immediately once a sweep is armed, triggering that is supplied by the GPIB, triggering on either the positive or negative edge of a signal supplied to the TRIGGER IN connector, or triggering by the front panel Trigger key.

Default Value: Immediate

Softkey Location: **Sweep/List > Sweep Trigger**

Sweep Type List Step

Toggles the sweep type from list sweep to step sweep. You create a list sweep by supplying the frequency, amplitude, and dwell time for each point in the sweep. You create a step sweep by supplying the start and stop frequency and amplitude, the number of points, and a dwell time. The signal generator then calculates the points between the first and last point in a linear manner.

Default Value: List

Softkey Location: **Sweep/List > Sweep Type List Step**

Trigger Key

This softkey is one of the choices in both the Sweep Trigger menu and the Point Trigger menu. Press either the **Sweep Trigger** softkey or the **Point Trigger** softkey to view these menus. Choosing **Trigger Key** in the Sweep Trigger menu immediately triggers an armed sweep when you press the **Trigger** front panel key. Choosing **Trigger Key** in the Point Trigger menu immediately triggers the next point in a running sweep.

Softkey Location: **Sweep/List > Sweep Trigger > Trigger Key**

Or: **Sweep/List > Point Trigger > Trigger Key**

Trigger Out Polarity Neg Pos

This softkey toggles the polarity of the TTL signal that is output at the rear panel TRIGGER OUT connector. When **Trigger Out Polarity Neg Pos** is set to **Pos** the output signal is asserted high (+5 V) at the start of a dwell sequence, or at the start of waiting for the point trigger, and low (0 V) when the dwell is over, or when the point trigger is received. Setting **Trigger Out Polarity Neg Pos** to **Neg** reverses the polarity where a high is 0 V and a low is +5 V.

This softkey is coupled to the **Trigger Out Polarity Neg Pos** softkey in the swept-sine AM, FM, Φ M, and LF Out menus. When the polarity is toggled for this softkey in any one of these menus, it affects all locations of the softkey.

Default Value: Pos

Softkey Location: Sweep/List > Trigger Out Polarity Neg Pos

Trigger

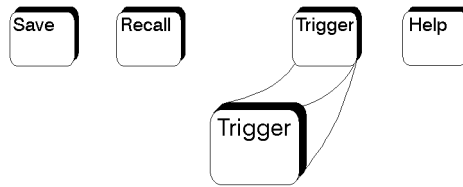

pk753a

Press this front panel hardkey to trigger a specified event or series of events.

- The **Trigger** key can start a step or list sweep under the following conditions:
 - Sweep mode is configured and turned on.
 - In single sweep mode, the sweep is armed.
 - The **Sweep Trigger** softkey, in the Sweep/List menu, is set to **Trigger Key**.
- The **Trigger** key can cause the sweep to step point by point in a step or list sweep under the following conditions:
 - Sweep mode is configured and turned on.
 - In single sweep mode, the sweep is armed.
 - The **Point Trigger** softkey, in the Sweep/List menu, is set to **Trigger Key**.
 - The sweep must be triggered if **Sweep Trigger** is not set to **Immediate**.

Also, under these conditions, the **Trigger** key has autorepeat capability. Hold it down and it will repeatedly trigger the consecutive points in the sweep.

- The **Trigger** key can start a single sweep of swept-sine amplitude, frequency, or phase modulation under the following conditions:
 - **Trigger Key** is selected in the AM, FM, or Φ M Sweep Trigger menu.
 - Swept-sine AM, FM, or Φ M is enabled.

Also, under these conditions, the **Trigger** key has autorepeat capability. Hold it down and it will repeatedly trigger the sweep. This has the effect of stopping the current sweep before it finishes, when the key repeat is detected.

- The **Trigger Key** can start an LF swept-sine output under the following conditions:
 - **Function Generator** is selected as the **LF Out Source**.
 - The **LF Out Sweep Trigger** is set to **Trigger Key**.
 - Swept-sine LF out is selected.

Also, under these conditions, the **Trigger** key has autorepeat capability. Hold it down and it will repeatedly trigger the sweep. This has the effect of stopping the current sweep before it finishes, when the key repeat is detected.

- With any of the digital modulation formats configured and turned on, the **Trigger** key can initiate a burst to output a frame or a data sequence under the following conditions:
 - The digital modulation format is configured and turned on.
 - The **Pattern Trigger** or **Frame Trigger** softkey in the digital modulation menu is set to **Trigger Key**.
- With a bit error rate test configured and turned on, the **Trigger** key can initiate a bit error rate test under the following conditions:
 - The bit error rate test is configured and turned on.
 - The **BERT Trigger** softkey in the bit error rate test menu is set to **Trigger Key**.

Utility

Pressing the front panel **Utility** key reveals a menu of softkeys. These softkeys are described in this section in alphabetical order.

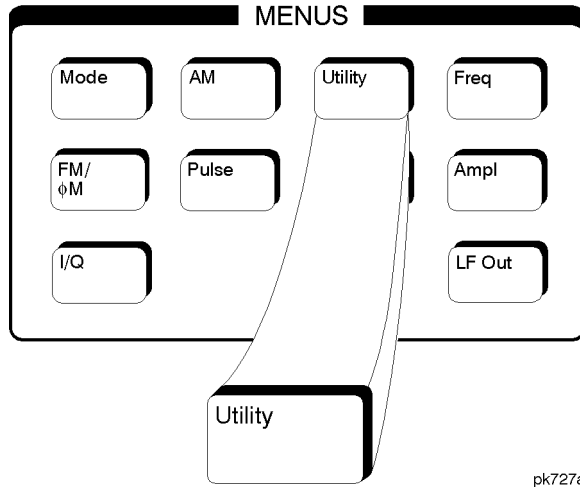

ARB

Press this softkey to set the current catalog type to ARB and display the catalog of ARB files.

Softkey Location: **Utility > Memory Catalog > Catalog Type > ARB Catalog Types > ARB**

ARB Catalog Types

Press this softkey to reveal a menu of ARB catalog type choices for displaying files.

Softkey Location: **Utility > Memory Catalog > Catalog Type > ARB Catalog Types**

Binary

Press this softkey to set the current catalog type to Binary and display the catalog of binary files.

Softkey Location: **Utility > Memory Catalog > Catalog Type > Binary**

Bit

Press this softkey to set the current catalog type to Bit and display the catalog of bit files.

Softkey Location: **Utility > Memory Catalog > Catalog Type > Bit**

Black Pixels Screen Test

This softkey is provided for factory use in testing the display. Pressing this softkey sets all the pixels on the display to black. Pressing the **Local** front panel key returns the display to normal signal generator operation.

Softkey Location: **Utility > Display > Black Pixels Screen Test**

Brightness

Use this softkey to adjust the display brightness (intensity). The display is set to maximum brightness at the factory. To change the brightness, press **Utility > Display > Brightness**. The current value shown in the active entry area is a relative value for brightness. Increasing the number increases the brightness; decreasing the number decreases the brightness. You can adjust the brightness value to any number from 1 through 50. (To adjust the brightness via remote operation, set the value from 0.02 to 1.0.) Use the front panel knob, the up and down arrow keys, or enter a value using the numeric keypad and press the **Enter** terminator softkey.

Brightness is a persistent state; it is not affected by an instrument preset or by a power cycle.

Softkey Location: **Utility > Display > Brightness**

Burst Gate In Polarity Neg Pos (Option UN8)

This softkey in the Signal Polarity Setup menu is used to configure the polarity of the TTL signal at the BURST GATE IN connector. Pos refers to normal logic, while Neg refers to inverted logic.

Default Value: Pos

Softkey Location: **Utility > Instrument Adjustments > Signal Polarity Setup > Burst Gate In Polarity Neg Pos**

Calibrate Selected Items

Press this softkey to perform a download of calibration data from the optional hardware into non-volatile memory. To confirm that you want to start the calibration, press the **Start Calibration and Store Results** softkey. The calibration takes several minutes. During the calibration, a message is displayed indicating the calibration is in progress and showing the percent complete. When the calibration is finished, the Hardware Options menu is returned.

Perform this calibration if you have just installed optional hardware in your signal generator. This calibration is not intended for repeated execution. Any further calibrations that may be required should be performed through the I/Q Calibration menu located in the I/Q key menus.

Softkey Location: **Utility > Instrument Adjustments > Hardware Options > Calibrate Selected Items**

Catalog Type

Pressing this softkey reveals a menu of choices for displaying files. You can choose to display all files or specific catalog types. When you have made your selection, the display is updated and your choice appears below the **Catalog Type** softkey. For information on file and memory management, refer to the remote data transfer guide, Chapter 4, “Understanding Signal Generator Memory Structure.” For information on storing and recalling files, refer to the “Using Functions,” chapter in the user’s and programming guide of the option you are using.

Catalog type is a persistent state; it is not changed by an instrument preset or by a power cycle.

Softkey Location: **Utility > Memory Catalog > Catalog Type**

CDMA

Press this softkey to set the current catalog type to CDMA and display the catalog of CDMA files.

Softkey Location: **Utility > Memory Catalog > Catalog Type > ARB Catalog Types > CDMA**

Clear Error Queue(s)

Press this softkey to delete any messages that are stored in the error message queues. (There are separate error queues for front panel operation and for SCPI. Pressing this softkey clears both.) You cannot recover from this action; once the messages are deleted, they are permanently gone. When the error message queue is empty, the ERR annunciator is turned off.

Softkey Location: **Utility > Error Info > Clear Error Queue(s)**

Clear Text

Press this softkey to delete the existing file name in the active entry area. When you copy from one file to another, the same file name is given to the new file unless you change it. Press **Clear Text** to delete the existing file name and then enter in a new file name using the editing keys provided.

Softkey Location: **Utility > Memory Catalog > Copy File > Editing Keys > Clear Text**

Copy File

Press this softkey to copy and rename a file in the displayed catalog of files. To copy a file, first select the file from the displayed list by scrolling through the list using the front panel knob or the up and down arrow keys. When the desired file is highlighted, press **Copy File**. The message **Copy to: "<file_name>"** is displayed in the active entry area where "<file_name>" is the name of the currently selected file. Your copied file will have the same name as the original file, so you must rename it. To rename the copied file, the following editing capabilities are provided:

- The **Editing Mode Insert Replace** softkey in the Editing Keys menu toggles the editing mode from inserting text to replacing text. Insertion mode causes text to be entered in the position directly to the right of the cursor. Replacement mode causes the text to be entered in the position held by the cursor (replacing any existing text in that position).
- The **Clear Text** softkey in the Editing Keys menu deletes all of the existing text in the active entry area.
- Use the left and right arrow keys to position the cursor. Use the front panel knob, or the direct editing softkeys, to enter an alphabetic character, numeral, or special character.

When you have entered the new file name, press the **Enter** terminator softkey. If you have changed your mind, press the **Return** hardkey. Once you press **Enter**, the new file is stored and displayed immediately in the catalog list.

Softkey Location: **Utility > Memory Catalog > Copy File**

DATA/CLK/SYNC Rear Outputs Off On (Option UN8)

This softkey in the Instrument Adjustments menu is used to disconnect the output signals from the rear panel DATA OUT, DATA CLK OUT, and SYMBOL SYNC OUT connectors. Normally, these output signals should be connected (softkey set to On position). However, disconnecting these outputs will decrease the spurs that are sometimes present when you are operating at high symbol rates.

Default Value: On

Softkey Location: Utility > Instrument Adjustments >
DATA/CLK/SYNC Rear Outputs Off On

Data Clock Out Polarity Neg Pos (Option UN8)

This softkey in the Signal Polarity Setup menu is used to configure the polarity of the TTL signal at the DATA CLOCK OUT connector. Pos refers to the rising edge, while Neg refers to the falling edge.

Default Value: Pos

Softkey Location: Utility > Instrument Adjustments > Signal Polarity Setup >
Data Clock Out Polarity Neg Pos

Data Clock Polarity Neg Pos (Option UN8)

This softkey in the Signal Polarity Setup menu is used to configure the polarity of the TTL signal at the DATA CLOCK connector. Pos refers to the rising edge, while Neg refers to the falling edge.

Default Value: Pos

Softkey Location: Utility > Instrument Adjustments > Signal Polarity Setup >
Data Clock Polarity Neg Pos

Data Out Polarity Neg Pos (Option UN8)

This softkey in the Signal Polarity Setup menu is used to configure the polarity of the TTL signal at the DATA OUT connector. Pos refers to normal logic, while Neg refers to inverted logic.

Default Value: Pos

Softkey Location: Utility > Instrument Adjustments > Signal Polarity Setup >
Data Out Polarity Neg Pos

Data Polarity Neg Pos (Option UN8)

This softkey in the Signal Polarity Setup menu is used to configure the polarity of the TTL signal at the DATA connector. Pos refers to normal logic, while Neg refers to inverted logic.

Default Value: Pos

Softkey Location: Utility > Instrument Adjustment > Signal Polarity Setup > Data Polarity Neg Pos

Delete All Files

Press this softkey to delete all of the files in the displayed catalog of files. You will then confirm that you want to delete all of the files in memory. Press the **Confirm Delete Of All Files** terminator softkey and all of the files are deleted.

CAUTION

You cannot recover files after this step. If you change your mind and do not wish to delete the files, press the **Return** front panel hardkey instead.

This softkey does not affect the persistent state or calibration information. If power on mode is set to last, a new last state file will be created when the instrument idles.

Softkey Location: Utility > Memory Catalog > Catalog Type > All > Delete All Files

Delete All <catalog type> Files

Press this softkey to delete all of the files in the displayed catalog of files of a selected catalog type. You must confirm that you want to delete all of the files. Press the **Confirm Delete Of <catalog type> Files** terminator softkey to delete all the files of the selected type.

CAUTION

You cannot recover files after this step. If you change your mind and do not wish to delete the files, press the **Return** front panel hardkey instead.

Softkey Location: Utility > Memory Catalog > Catalog Type > <catalog type> > Delete All <catalog type> Files

Delete File

Press this softkey to delete a file in the displayed catalog of files. To delete a file, first select the file from the displayed list by scrolling through the list using the front panel knob or up and down arrow keys. When the desired file is highlighted, press **Delete File**. Then press the **Confirm Delete** terminator softkey and the file is deleted. You cannot recover the file after this step. If you have changed your mind and do not wish to delete the file, press the **Return** front panel hardkey instead.

Softkey Location: Utility > Memory Catalog > Delete File

Deselect All Items

Press this softkey to deselect all options in the list of hardware options. Selected options show an X in the column to the left of the option number. Deselected options have no X. Only those options that are selected can be enabled or calibrated.

Softkey Location: **Utility > Instrument Adjustments > Hardware Options > Deselect All Items**

Deselect Item

Press this softkey to deselect the highlighted option in the list of hardware options. Selected options show an X in the column to the left of the option number. Deselected options have no X. Only those options that are selected can be enabled or calibrated.

Softkey Location: **Utility > Instrument Adjustments > Hardware Options > Deselect Item**

Diagnostic Info

Press this softkey for a display of diagnostic information about the signal generator. The following information is included in the display:

- instrument model
- instrument options
- instrument serial number
- current firmware revision
- current firmware date
- number of hours the signal generator has been powered on
- number of hours the display has been lit
- number of power cycles
- number of attenuator cycles
- number of reverse power protection trips

Softkey Location: **Utility > Instrument Info/Help Mode > Diagnostic Info**

Display

Pressing this softkey reveals a menu of choices for adjusting and testing the display. In this menu you are able to set up the screen saver, change the display brightness, and perform black and white pixel screen tests.

Softkey Location: **Utility > Display**

DMOD

Press this softkey to set the current catalog type to DMOD and display the catalog of DMOD files.

Softkey Location: **Utility > Memory Catalog > Catalog Type > ARB Catalog Types > DMOD**

DWCDMA

Press this softkey to set the current catalog type to DWCDMA and display the catalog of DWCDMA files.

Softkey Location: **Utility > Memory Catalog > Catalog Type > ARB Catalog Types > DWCDMA**

Editing Keys

Pressing this softkey reveals a menu of choices for editing the name of a file you have just copied. When you copy a file, its name is copied also. As you cannot have two identical file names, use this menu to edit the file name of the copied file. In this menu you can delete the existing text in the active entry area (either the copied file name, or a file name that you have subsequently entered), and you can toggle the editing mode from inserting text to replacing text.

Softkey Location: **Utility > Memory Catalog > Copy File > Editing Keys**

Editing Mode Insert Replace

Press this softkey to toggle the editing mode from inserting text to replacing text. Insertion mode causes text to be entered in the position directly to the right of the cursor. Replacement mode causes the text to be entered in the position held by the cursor (replacing any existing text in that position).

Softkey Location: **Utility > Memory Catalog > Copy File > Editing Keys > Editing Mode Insert Replace**

EFC Lock Off On (ESG-AP and ESG-DP Models)

This softkey enables an Electronic Frequency Control mode that is for use with phase noise systems. It is provided for use by service personnel only.

Softkey Location: **Utility > Instrument Adjustments > Reference Oscillator Adjustment > EFC Lock Off On**

Error Info

Pressing this softkey reveals a menu of choices for viewing error messages. In this menu you can view any of the error messages in the queue, and you can clear all of the error messages in the queue.

Softkey Location: Utility > Error Info

Event 1 Polarity Neg Pos (Option UN8)

This softkey in the Signal Polarity Setup menu is used to configure the polarity of the TTL signal out at the EVENT 1 connector. Pos refers to normal logic, while Neg refers to inverted logic.

Default Value: Pos

Softkey Location: Utility > Instrument Adjustments > Signal Polarity Setup > Event 1 Polarity Neg Pos

Event 2 Polarity Neg Pos (Option UN8)

This softkey in the Signal Polarity Setup menu is used to configure the polarity of the TTL signal out at the EVENT 2 connector. Pos refers to normal logic, while Neg refers to inverted logic.

Default Value: Pos

Softkey Location: Utility > Instrument Adjustments > Signal Polarity Setup > Event 2 Polarity Neg Pos

FCDMA

Press this softkey to set the current catalog type to FCDMA and display the catalog of FCDMA files.

Softkey Location: Utility > Memory Catalog > Catalog Type > ARB Catalog Types > FCDMA

FIR

Press this softkey to set the current catalog type to FIR and display the catalog of FIR files.

Softkey Location: Utility > Memory Catalog > Catalog Type > FIR

FSK

Press this softkey to set the current catalog type to FSK and display the catalog of FSK files.

Softkey Location: Utility > Memory Catalog > Catalog Type > Modulation Catalog Types > FSK

FWCDMA

Press this softkey to set the current catalog type to FWCDMA and display the catalog of FWCDMA files.

Softkey Location: Utility > Memory Catalog > Catalog Type >
ARB Catalog Types > FWCDMA

Hardware Options

This softkey accesses a menu where you can configure your signal generator to enable or to disable any hardware option that you have purchased. Refer to [Chapter 2, “Using Functions,”](#) for an example of using this function. This menu also provides the capability of performing a download of calibration data from the optional hardware into non-volatile memory.

CAUTION

If you enable an option that does not have the required hardware installed, the menus for that option will be activated but the option *cannot* operate, despite what the menus may seem to indicate.

This menu also provides the capability of performing a download of calibration data from the optional hardware into non-volatile memory.

Softkey Location: Utility > Instrument Adjustments > Hardware Options

Help Mode Single Cont

This softkey toggles the help mode between single and continuous. In single mode, when you press the **Help** key, help text is provided for the next front panel hardkey or softkey that you press. Your next key press returns you to normal operation. In continuous mode, when you press the **Help** key, help text is provided for the next front panel hardkey or softkey that you press and that key's function is also executed. You will stay in this help mode until you press the **Help** key again.

Help mode is a persistent state; it is not affected by an instrument preset or by a power cycle.

Softkey Location: Utility > Instrument Info/Help Mode > Help Mode Single Cont

8648A/B/C/D

This softkey is one of the choices in both the Preset Language menu and the Remote Language menu. The **8648A/B/C/D** softkey is a language choice for the signal generator that is compatible with the remote language commands used by the 8648A/B/C/D. Choosing **8648A/B/C/D** in the Preset Language menu allows you to select this remote language as the default after a normal preset. Choosing **8648A/B/C/D** in the Remote Language menu allows you to immediately change the signal generator to use this remote language.

Softkey Location: Utility > Power On/Preset > Preset Language > 8648A/B/C/D

Or: Utility > GPIB/RS-232 > Remote Language > 8648A/B/C/D

8656B,8657A/B

This softkey is one of the choices in both the Preset Language menu and the Remote Language menu. The **8656B,8657A/B** softkey is a language choice for the signal generator that is compatible with the remote language commands used by the 8656B and the 8657A/B. See the 8656/57 Compatibility table in the Softkey/Command Cross-Reference chapter of the programming guide. Choosing **8656B,8657A/B** in the Preset Language menu allows you to select this remote language as the default after a normal preset. Choosing **8656B,8657A/B** in the Remote Language menu allows you to immediately change the signal generator to use this remote language.

Softkey Location: Utility > Power On/Preset > Preset Language > 8656B,8657A/B

Or: Utility > GPIB/RS-232 > Remote Language > 8656B,8657A/B

8657D NADC (Option UN8)

This softkey is one of the choices in both the Preset Language menu and the Remote Language menu. The **8657D NADC** softkey is a language choice for the signal generator that is compatible with the remote language commands used by the 8657D with NADC digital modulation capabilities. Choosing **8657D NADC** in the Preset Language menu allows you to select this remote language as the default after a normal preset. Choosing **8657D NADC** in the Remote Language menu allows you to immediately change the signal generator to use this remote language.

Softkey Location: Utility > Power On/Preset > Preset Language > 8657D NADC

Or: Utility > GPIB/RS-232 > Remote Language > 8657D NADC

8657D PDC (Option UN8)

This softkey is one of the choices in both the Preset Language menu and the Remote Language menu. The **8657D PDC** softkey is a language choice for the signal generator that is compatible with the remote language commands used by the 8656D with PDC digital modulation capabilities. Choosing **8657D PDC** in the Preset Language menu allows you to select this remote language as the default after a normal preset. Choosing **8657D PDC** in the Remote Language menu allows you to immediately change the signal generator to use this remote language.

Softkey Location: Utility > Power On/Preset > Preset Language > **8657D PDC**

Or: Utility > GPIB/RS-232 > Remote Language > **8657D PDC**

8657J PHS (Option UN8)

This softkey is one of the choices in both the Preset Language menu and the Remote Language menu. The **8657J PHS** softkey is a language choice for the signal generator that is compatible with the remote language commands used by the 8657J with PHS digital modulation capabilities. Choosing **8657J PHS** in the Preset Language menu allows you to select this remote language as the default after a normal preset. Choosing **8657J PHS** in the Remote Language menu allows you to immediately change the signal generator to use this remote language.

Softkey Location: Utility > Power On/Preset > Preset Language > **8657J PHS**

Or: Utility > GPIB/RS-232 > Remote Language > **8657J PHS**

GPIB Address

Press this softkey to change the signal generator's GPIB address. The GPIB address is set to 19 at the factory. You can change the address to any number between 0 and 30. To enter a new value, press **Utility > GPIB/RS-232 > GPIB Address** and rotate the front panel knob, use the up and down arrow keys, or enter the value using the numeric keypad and press the **Enter** terminator softkey.

The GPIB address setting is a persistent state; it is not affected by an instrument preset or by a power cycle.

Softkey Location: Utility > GPIB/RS-232 > **GPIB Address**

GPIB/RS-232

Pressing this softkey reveals a menu of choices for GPIB and RS-232 configuration. In this menu, you have the following options:

- change the GPIB address of the signal generator
- change the remote language of the signal generator
- set the baud rate for the RS-232 serial port (AUXILIARY INTERFACE connector)
- reset the RS-232 serial I/O
- turn the RS-232 echo on or off
- set the RS-232 handshake protocol
- control RS-232 RTS and CTS behavior

Softkey Location: **Utility > GPIB/RS-232**

Installed Board Info

Pressing this softkey displays information regarding the board assemblies installed in the signal generator, including:

- board assembly name
- part number
- board assembly serial number
- version

Depending on the options present, these board assemblies may include the motherboard, the dual arbitrary waveform generator, the baseband generator, the data generator, RF output, the reference output, or the signal generator.

Softkey Location: **Utility > Instrument Info/Help Mode > Installed Board Info**

Instrument Adjustments

Pressing this softkey reveals a menu of front panel adjustments for the signal generator. The softkeys in this menu provide the following capabilities:

- adjust the ratio between the front panel knob and the step size for the arrow keys
- adjust the internal reference oscillator (for use by service personnel only)
- install and remove hardware and software options

Softkey Location: **Utility > Instrument Adjustments**

Instrument Info/Help Mode

Pressing this softkey reveals a menu of softkeys for the following functions:

- display diagnostic information about your signal generator
- turn on and off the display of information about the status of the modulation modes
- toggle the help mode between single and continuous

Softkey Location: Utility > Instrument Info/Help Mode

Inverse Video Off On

The normal display mode for the signal generator is dark text on a light background. Press this softkey to toggle inverse video on (light text on a dark background).

Inverse video is a persistent state; it is not affected by an instrument preset or by a power cycle.

Softkey Location: Utility > Display > Inverse Video Off On

I/Q

Press this softkey to set the current catalog type to I/Q and display the catalog of I/Q files.

Softkey Location: Utility > Memory Catalog > Catalog Type > Modulation Catalog Types > I/Q

List

Press this softkey to set the current catalog type to List and display the catalog of list files.

Softkey Location: Utility > Memory Catalog > Catalog Type > List

MCDMA

Press this softkey to set the current catalog type to MCDMA and display the catalog of MCDMA files.

Softkey Location: Utility > Memory Catalog > Catalog Type > ARB Catalog Types > MCDMA

Memory Catalog

Displays the catalog of user files, and softkeys for choosing the type of files displayed. See [Chapter 5, “Memory Structure,”](#) for details.

Softkey Location: Utility > Memory Catalog

MDMOD

Press this softkey to set the current catalog type to MDMOD and display the catalog of MDMOD files.

Softkey Location: Utility > Memory Catalog > Catalog Type >
ARB Catalog Types > MDMOD

MDWCDMA

Press this softkey to set the current catalog type to MDWCDMA and display the catalog of MDWCDMA files.

Softkey Location: Utility > Memory Catalog > Catalog Type >
ARB Catalog Types > MDWCDMA

MFCDMA

Press this softkey to set the current catalog type to MFCDMA and display the catalog of MFCDMA files.

Softkey Location: Utility > Memory Catalog > Catalog Type >
ARB Catalog Types > MFCDMA

MFWCDMA

Press this softkey to set the current catalog type to MFWCDMA and display the catalog of MFWCDMA files.

Softkey Location: Utility > Memory Catalog > Catalog Type >
ARB Catalog Types > MFWCDMA

Modify License Key

Press this softkey to enter the license key for the highlighted software option. Software options are linked to specific optional hardware that must first be installed before the software option can be operational. Adding new software options requires the use of a license key that is provided by Agilent Technologies at the time of purchase. Once the license key is entered, the software option will be enabled when you press the **Proceed with Reconfiguration** softkey. Refer to [Chapter 2, “Using Functions,”](#) for an example of using this function.

CAUTION

If you enable an option that does not have the required hardware installed, the menus for that option will be activated but the option *cannot* operate, despite what the menus may seem to indicate.

Softkey Location: Utility > Instrument Adjustments > Software Options >
Modify License Key

Mod Status Info Off On

Press this softkey to toggle on and off the modulation status display. When the modulation status is set to on, information about the status of all of the modulations available is shown at any time that you have accessed one of the modulation menus. When the modulation status is set to off, the information about the status of all the modulations is never displayed.

Default Value: On

Softkey Location: Utility > Instrument Info/Help Mode > Mod Status Info Off On

Modulation Catalog Types

Press this softkey to reveal a menu of Modulation catalog type choices for displaying files.

Softkey Location: Utility > Memory Catalog > Catalog Type > Modulation Catalog Types

MTONE

Press this softkey to set the current catalog type to MTONE and display the catalog of MTONE files.

Softkey Location: Utility > Memory Catalog > Catalog Type > ARB Catalog Types > MTONE

NVARB

Press this softkey to set the current catalog type to NVARB and display the catalog of NVARB files.

Softkey Location: Utility > Memory Catalog > Catalog Type > ARB Catalog Types > NVARB

Off

Press this softkey to turn the RTS line off. In this mode, the instrument will ignore the state of the CTS line (3-wire connection). This setting is not compatible with the 83300A Remote Interface.

RTS is a persistent state; it is not affected by an instrument preset or by a power cycle.

Softkey Location: Utility > GPIB/RS-232 > RS-232 Pace > RTS/CTS > Off

Options Info

Press this softkey to retrieve information regarding the options installed in the instrument. This information may include any of the following information:

- Option number: the alpha or numeric designation of the installed option, for instance: option UN8, UNB or 300.
- Hardware version: the letter designation of the installed hardware for the listed option number, for instance: UN8 or UN9 – version C, or UN7 – version A.
- DSP version: the name of the DSP (digital signal processor) firmware version for the installed option card.

Softkey Location: Utility > Instrument Info/Help Mode > Options Info

Page Down

Press this softkey to move down in the displayed catalog of files one page at a time.

Softkey Location: Utility > Memory Catalog > Page Down or Utility > Memory Catalog > Goto Row > Page Down

Page Up

Press this softkey to move up in the displayed catalog of files one page at a time.

Softkey Location: Utility > Memory Catalog > Page Up or Utility > Memory Catalog > Goto Row > Page Up

Pattern Trigger In Polarity Neg Pos (Option UN8)

This softkey in the Signal Polarity Setup menu is used to configure the polarity of the TTL signal at the PATTERN TRIG IN connector that triggers an event. Pos refers to the rising edge, while Neg refers to the falling edge.

Default Value: Pos

Softkey Location: Utility > Instrument Adjustments > Signal Polarity Setup > Trigger In Polarity Neg Pos

PN9 Mode Preset Normal Quick (Option UN8)

This softkey sets the preset value for the PN9 mode. The choices are Normal and Quick. PN9 mode only applies to personalities that require software PRBS.

Default Value: Normal

Softkey Location: Utility > Power On/Preset > PN9 Mode Preset Normal Quick

Power On Last Preset

This softkey toggles the power-on state of the signal generator between **Last** and **Preset**.

- If you choose **Last**, each time you cycle power to the signal generator it will turn on in the same condition as when you turned power off. The signal generator must not receive commands for a second before the power is turned off to guarantee that the most recent state is saved.
- If you choose **Preset**, each time you cycle power to the signal generator it will turn on in either the factory-defined preset condition or in a user-defined preset condition. You make the choice between factory- and user-defined preset with the **Preset Normal User** softkey.

The power-on state is a persistent state; it is not affected by an instrument preset or by a power cycle.

Softkey Location: **Utility > Power On/Preset > Power On Last Preset**

Power On/Preset

Pressing this softkey reveals a menu of choices for preset conditions. In this menu, you have the following options:

- Set the signal generator to power on in the same state as it was when you powered off, or to power on in the instrument preset state. (Refer to the [Power On Last Preset](#) softkey description, in this section.)
- Set the signal generator to preset to a factory-defined state or to a user-defined state. (Refer to the [Preset Normal User](#) softkey description, in this section.)
- Set up your own user-defined preset state. (Refer to the [Save User Preset](#) softkey description, in this section.)
- Set the signal generator to preset to the SCPI programming language or to an 8648 or 8656/57-compatible language. (Refer to the [Preset Language](#) softkey description, in this section.)
- Set the signal generator's reverse power protection to the factory-defined state or to an 8648-equivalent state. (Refer to the [Reverse Power Protection Normal 8648](#) softkey description.)

Softkey Location: **Utility > Power On/Preset**

Preset Language

Pressing this softkey reveals a menu of choices for selecting the programming language that is implemented after the **Preset** key is pressed. You can choose between SCPI, which is the language chosen for the signal generator for remote implementation of all features, 8648-compatible, and four versions of 8656/57-compatible languages. The 8648- and 8656/67-compatible languages are provided for remote implementation of some features so that this signal generator can be compatible with systems that use those instruments. Refer to the programming guide for specifics on which commands are implemented.

The preset language is a persistent state; it is not affected by an instrument preset or by a power cycle.

Softkey Location: **Utility > Power On/Preset > Preset Language**

Preset Normal User

This softkey toggles the preset state between the factory-defined and the user-defined states. You choose the instrument state conditions for the user-defined preset state. Refer to the **Save User Preset** softkey description in this section.

The preset state is a persistent state; it is not changed by an instrument preset or by a power cycle.

Softkey Location: **Utility > Power On/Preset > Preset Normal User**

Proceed With Reconfiguration

Press this softkey to enable the selected hardware or software options. In the Hardware Options menu, selected options are indicated by an X in the column to the left of the option number. In the Software Options menu, selected options include any options that have a license key entered. After pressing this softkey, press the **Confirm Change** softkey to verify that you do want to reconfigure the signal generator with the options that you have selected. If you do not want to continue, press the Return key. Refer to **Chapter 2, "Using Functions,"** for an example of using this function.

CAUTION

If you enable an option that does not have the required hardware installed, the menus for that option will be activated but the option *cannot* operate, despite what the menus may seem to indicate.

Softkey Location: **Utility > Instrument Adjustments > Hardware Options > Proceed With Reconfiguration**

Or: **Utility > Instrument Adjustments > Software Options > Proceed With Reconfiguration**

RCDMA

Press this softkey to set the current catalog type to RCDMA and display the catalog of RCDMA files.

Softkey Location: Utility > Memory Catalog > Catalog Type >
ARB Catalog Types > RCDMA

Recall Ref Osc Setting

This softkey is provided for adjusting the internal reference oscillator. This adjustment is for use by service personnel only. Refer to the calibration guide for more information.

Softkey Location: Utility > Instrument Adjustments >
Reference Oscillator Adjustment > Recall Ref Osc Setting

Receive Pace None Xon

This softkey in the RS-232 Pace menu determines whether any pacing is acknowledged by the RS-232 receive channel. If Xon pacing is used, the system will send an Xoff character to suspend the transmitting of data when its buffer is nearly full. When the system is ready to receive further input, an Xon character is sent to the transmitting device. Xon pacing is not recommended if binary data will be queried from the signal generator via RS-232. Toggle Receive Pace None Xon to None to turn off Xon pacing.

Pace is a persistent state; it is not affected by an instrument preset or by a power cycle.

Softkey Location: Utility > GPIB/RS-232 > RS-232 Pace >
Receive Pace None Xon

Reference Oscillator Adjustment

Pressing this softkey reveals a menu of softkeys for adjusting the internal reference oscillator. This adjustment is for use by service personnel only.

Softkey Location: Utility > Instrument Adjustments >
Reference Oscillator Adjustment

Ref Osc Coarse

This softkey is provided for adjusting the internal reference oscillator. This adjustment is for use by service personnel only. Refer to the calibration guide for more information.

Softkey Location: Utility > Instrument Adjustments >
Reference Oscillator Adjustment > Ref Osc Coarse

Ref Osc Fine

This softkey is provided for adjusting the internal reference oscillator. This adjustment is for use by service personnel only. Refer to the calibration guide for information.

Softkey Location: **Utility > Instrument Adjustments > Reference Oscillator Adjustment > Ref Osc Fine**

Remote Language

Pressing this softkey reveals a menu of choices for immediately changing the signal generator's remote language. You can choose between SCPI, which is the language chosen for the signal generator for remote implementation of all features, 8648-compatible, and four versions of 8656/57-compatible languages. The 8648- and 8656/67-compatible languages are provided for remote implementation of some features so that this signal generator can be compatible with systems that use those instruments. Refer to the programming guide for specifics on which commands are implemented.

Default Value: Depends on the value of the Preset Language.

Softkey Location: **Utility > GPIB/RS-232 > Remote Language**

Rename File

Press this softkey to rename a file in the displayed catalog of files. The following text explains how to use the file name editor:

- The **Editing Mode Insert Replace** softkey in the Editing Keys menu toggles the editing mode from inserting text to replacing text. Insertion mode causes text to be entered in the position directly to the right of the cursor. Replacement mode causes the text to be entered in the position held by the cursor (replacing any existing text in that position).
- The **Clear Text** softkey in the Editing Keys menu deletes all of the existing text in the active entry area.
- Use the left and right arrow keys to position the cursor. Use the front panel knob, or the direct editing softkeys, to enter an alphabetic character, numeral, or special character.

When you have entered the new file name, press the **Enter** terminator softkey. If you have changed your mind, press the **Return** hardkey. Once you press **Enter**, the new file is stored and displayed immediately in the catalog list.

Softkey Location: **Utility > Memory Catalog > Rename File**

Reset RS-232

Press this softkey to perform a clean-up on the RS-232 buffer which will discard any unprocessed SCPI input received over RS-232 and places the RS-232 connection in a mode which can detect the optional remote interface. All other RS-232 communication parameters (such as baud rate) are unaffected.

Softkey Location: Utility > GPIB/RS-232 > Reset RS-232

Restore Default Signal Polarities (Option UN8)

This softkey in the Signal Polarity Setup menu is used to restore the instrument's default signal polarities

Softkey Location: Utility > Instrument Adjustments > Signal Polarity Setup > Restore Default Signal Polarities

Reverse Power Protection Normal 8648

Toggles the reverse power protection mode between the normal mode for the signal generator and the 8648-compatible mode.

When you have selected **Normal** and you trip the reverse power protection circuit, a caution message is displayed and the front panel is locked. Eliminate the source of the excess reverse power detected at the RF OUTPUT connector. Then press the **Reset RPP** softkey to continue normal signal generator operation.

When you have selected **8648** and you trip the reverse power protection circuit, a caution message is displayed and the front panel is locked. However, any command sent over GPIB will reset the RPP circuit and return you to normal signal generator operation. This mode is provided for compatibility with systems that use the 8648. It is only available when you have selected 8648A/B/C/D remote language. At all other times reverse power protection is set to **Normal**. Operate in this mode with *caution*. Repeatedly tripping the RPP can cause damage to the signal generator. It is still best to eliminate the source of the excess reverse power and then reset the reverse power protection circuit by pressing the **Reset RPP** softkey.

The RPP reset mode is a persistent state; it is not affected by an instrument preset or by a power cycle.

Softkey Location: Utility > Power On/Preset >
Reverse Power Protection Normal 8648

RS-232 Baud Rate

Press this softkey to set the baud rate in bits per second for the rear panel RS-232 connector (this connector is labeled AUXILIARY INTERFACE). To change the baud rate press the softkey. A menu is displayed of baud rates that are allowed. Press the softkey for the desired value. The baud rate is now set to the new value and the value is displayed below the RS-232 Baud Rate softkey.

Baud rate is a persistent state; it is not affected by an instrument preset or by a power cycle.

Softkey Location: Utility > GPIB/RS-232 > RS-232 Baud Rate

RS-232 Echo Off On

This softkey toggles the echo function on and off for the RS-232 serial port (AUXILIARY INTERFACE connector). When echo is set to on, every character sent to the signal generator is immediately sent back. No editing capability is available.

Echo is not affected by an instrument preset or by a power cycle.

Softkey Location: Utility > GPIB/RS-232 > RS-232 Echo Off On

RS-232 Pace

Pressing this softkey reveals a menu of choices for setting the RS-232 handshake protocol. In this menu you can choose transmit pacing, receive pacing, and RTS/CTS control.

Softkey Location: Utility > GPIB/RS-232 > RS-232 Pace

RS-232 Timeout

Pressing this softkey allows changes to the value for the RS-232 serial port timeout. If further input is not received within the assigned timeout period while a SCPI command is being processed, then the command is aborted and the input buffer is cleared.

Timeout is a persistent state; it is not affected by an instrument preset or by a power cycle.

Softkey Location: Utility > GPIB/RS-232 > RS-232 Timeout

RTS/CTS

Pressing this softkey reveals a menu of choices for controlling the RTS/CTS behavior. This feature is used with RS-232 connections, including the 83300A Remote Interface.

RTS is a persistent state; it is not affected by an instrument preset or by a power cycle.

Softkey Location: **Utility > GPIB/RS-232 > RS-232 Pace > RTS/CTS**

RTS/CTS Pacing

Press this softkey to turn the RTS line on and instruct the signal generator to monitor the state of the CTS line (hardware handshaking). The signal generator monitors CTS and suspends transmission if this line transitions to its logically low state. Up to 16 characters may still be transmitted after the low transition. The signal generator will drop RTS if its receive buffer is nearly full. RTS will be raised again when there is sufficient room in the buffer. This setting is not compatible with an 83300A Remote Interface. Do not attempt to use this setting with a 3-wire connection.

RTS is a persistent state; it is not affected by an instrument preset or by a power cycle.

Softkey Location: **Utility > GPIB/RS-232 > RS-232 Pace > RTS/CTS > RTS/CTS Pacing**

RTS On

Press this softkey to turn the RTS line on. In this mode, the instrument will ignore the state of the CTS line (3-wire connection). This setting is intended for use with an 83300A Remote Interface, but it will also work with a 3-wire connection. **RTS On** is the default setting for the signal generator.

RTS is a persistent state; it is not affected by an instrument preset or by a power cycle.

Softkey Location: **Utility > GPIB/RS-232 > RS-232 Pace > RTS/CTS > ON**

RWCDMA

Press this softkey to set the current catalog type to RWCDMA and display the catalog of RWCDMA files.

Softkey Location: **Utility > Memory Catalog > Catalog Type > ARB Catalog Types > RWCDMA**

Save User Preset

Use this softkey to establish your user-defined preset state. Set up all of the instrument state conditions that you want for your unique preset state. When you have defined the instrument state to suit your needs, press **Save User Preset**. Only one user-defined preset state is allowed, so when you save the instrument state you will save over any previously-saved state. Your instrument state will be recalled by the signal generator any time you press **Preset** as long as you have set the **Preset Normal User** softkey to **User**. For additional information about the **Preset Normal User** softkey, refer to its description in this section.

The user's state definition is a state file; it is not affected by an instrument preset or by a power cycle.

Softkey Location: **Utility > Power On/Preset > Save User Preset**

SCPI

This softkey is one of the choices in both the Preset Language menu and the Remote Language menu. Press either the **Preset Language** softkey or the **Remote Language** softkey to view these menus. SCPI (Standard Commands for Programmable Instruments) is the language chosen for remote implementation of all supported instrument features. Choosing **SCPI** in the Preset Language menu allows you to select this remote language as the default after a normal preset. Choosing **SCPI** in the Remote Language menu allows you to immediately change the signal generator to use this remote language.

Softkey Location: **Utility > Power On/Preset > Preset Language > SCPI**

Or: **Utility > GPIB/RS-232 > Remote Language > SCPI**

Screen Saver Delay

This softkey sets the period of time before the screen saver is activated. The screen saver delay is set to 1 hour at the factory. You can change the delay by pressing **Utility > Display > Screen Saver Delay**. The current value for delay is displayed in the active entry area. To enter a new value, rotate the front panel knob, use the up and down arrow keys, or enter the value using the numeric keypad and press the **Enter** terminator softkey. The range of values allowed is 1 through 12 hours in 1 hour increments.

Screen saver delay is a persistent state; it is not affected by an instrument preset or by a power cycle.

Softkey Location: **Utility > Display > Screen Saver Delay**

Screen Saver Mode

This softkey toggles between **Light Only** and **Light & Text** mode for the screen saver. When you set the screen saver to **Light Only**, only the display light is turned on and off. When you set the screen saver to **Light & Text**, the display light and the text are turned on and off.

Screen saver mode is a persistent state; it is not affected by an instrument preset or by a power cycle.

Softkey Location: **Utility > Display > Screen Saver Mode**

Screen Saver Off On

This softkey toggles the signal generator's screen saver on and off. With the screen saver on, the display is turned off after a period of time with no input from the front panel. The display turns back on when any front panel key is pressed. The screen saver is set to **Off** at the factory. You can turn it on by pressing **Utility > Display Screen Saver**. Each time you press **Screen Saver Off On** the selection toggles between **Off** and **On**.

You can adjust the screen saver mode to turn the light on and off or to turn both the light and text on and off. Refer to the [Screen Saver Mode](#) softkey description in this section.

The screen saver delay is set to 1 hour at the factory. You can change the delay time. Refer to the [Screen Saver Mode](#) softkey description in this section.

Screen saver is a persistent state; it is not affected by an instrument preset or by a power cycle.

Softkey Location: **Utility > Display > Screen Saver Off On**

Select Item

Press this softkey to select the highlighted option from the list of hardware options. Selected options show an X in the column to the left of the option number. Two operations can be performed upon the selected options. The signal generator can be configured with these options enabled (by pressing the **Proceed With Reconfiguration** softkey), or the selected options can be calibrated (by pressing the **Calibrate Selected Items** softkey). For more information, refer to the descriptions of the softkeys mentioned, or refer to [Chapter 2, "Using Functions,"](#) for an example of enabling options.

Softkey Location: **Utility > Instrument Adjustments > Hardware Options > Select Item**

Seq

Press this softkey to set the current catalog type to Seq and display the catalog of sequence files.

Softkey Location: **Utility > Memory Catalog > Catalog Type > ARB Catalog Types > Seq**

Shape

Press this softkey to set the current catalog type to Shape and display the catalog of shape files.

Softkey Location: **Utility > Memory Catalog > Catalog Type > Shape**

Software Options

This softkey accesses a menu where you can configure your signal generator to enable any software option that you have purchased. Software options are linked to specific optional hardware that must first be installed before the software option can be operational. Adding new software options requires the use of a license key that is provided by Agilent Technologies at the time of purchase.

NOTE

If a previously installed software option is disabled, verify that the optional hardware is installed, the hardware option is enabled, and the software option is enabled with the correct license key. Refer to your License Key Certificate for the correct license key or, if the option was installed by Agilent Technologies, contact your local service office and tell them the instrument's model number, the host ID number, and the software option that should be enabled.

CAUTION

Don't modify the license key for enabled software options. You will disable the option.

Refer to [Chapter 2, "Using Functions,"](#) for an example of enabling software options.

Softkey Location: **Utility > Instrument Adjustments > Software Options**

State

Press this softkey to set the current catalog type to State and display the catalog of state files.

Softkey Location: **Utility > Memory Catalog > Catalog Type > State**

Step/Knob Ratio

This softkey sets the ratio between the increment value of the step keys and the front panel knob. For example, if you set the increment value for frequency to 1 MHz and set the step/knob ratio to 10/1, when frequency is the active function the up and down arrow keys will change the frequency in 1 MHz steps and the front panel knob will change the frequency in 1/10th of 1 MHz steps. This ratio only applies when you have a function active that has an associated increment value.

When you press **Step/Knob Ratio** the number displayed in the active entry area represents the arrow keys step size in the ratio. To enter a new value, rotate the front panel knob until the desired value is displayed, use the up and down arrow keys, or enter the value using the numeric keypad and press the **Enter** terminator softkey.

The step/knob ratio is a persistent state; it is not affected by an instrument preset or by a power cycle.

Softkey Location: **Utility > Instrument Adjustments > Step/Knob Ratio**

Store Ref Osc Setting

This softkey is provided for adjusting the internal reference oscillator. This adjustment is for use by service personnel only. Refer to the calibration guide for more information.

Softkey Location: **Utility > Instrument Adjustments > Reference Oscillator Adjustment > Store Ref Osc Setting**

Symbol Sync Out Polarity Neg Pos (Option UN8)

This softkey in the Signal Polarity Setup menu is used to configure the polarity of the TTL signal at the SYMBOL SYNC OUT connector. Pos refers to normal logic, while Neg refers to inverted logic.

Default Value: Pos

Softkey Location: **Utility > Instrument Adjustments > Signal Polarity Setup > Symbol Sync Out Polarity Neg Pos**

Symbol Sync Polarity Neg Pos (Option UN8)

This softkey in the Signal Polarity Setup menu is used to configure the polarity of the TTL signal at the SYMBOL SYNC connector. Pos refers to normal logic, while Neg refers to inverted logic.

Default Value: Pos

Softkey Location: **Utility > Instrument Adjustments > Signal Polarity Setup > Symbol Sync Polarity Neg Pos**

Transmit Pace None Xon

This softkey in the RS-232 Pace menu determines whether any pacing is acknowledged by the RS-232 transmit channel. If Xon pacing is used, the system will suspend transmitting data upon receiving an Xoff character until an Xon character is received. The signal generator may not be responsive to other channels, or to the front panel, while transmission is suspended. Xon pacing is not recommended if binary data will be sent to the signal generator via RS-232. Toggle **Transmit Pace None Xon** to **None** to turn off Xon pacing.

Pace is a persistent state; it is not affected by an instrument preset or by a power cycle.

Softkey Location: **Utility > GPIB/RS-232 > RS-232 Pace > Transmit Pace None Xon**

Update in Remote Off On

This softkey toggles between the display updating off or on, when the remote control bus is in remote.

This is a persistent state in the preset mode. However, it resets to off, the default value, when the power is cycled.

Softkey Location: **Utility > Display > Update in Remote**

UWCDMA

Press this softkey to set the current catalog type to UWCDMA and display the catalog of UWCDMA files.

Softkey Location: **Utility > Memory Catalog > Catalog Type > ARB Catalog Types > UWCDMA**

View Next Error Message

If the **ERR** annunciator is turned on in the display, you have at least one error message stored in the error message queue. Use this softkey to display the first error message in the queue. (The first error message is the oldest error.) There may be more than one error message in the queue; the number of error messages is displayed along with the first message. If there is more than one message, continue pressing this softkey to view the rest of the error messages. If you wish to back up and view a message you have already seen, press **View Previous Error Message**. Press any front panel key to remove the error message from the display and return to normal signal generator operation.

The error queue can contain up to 30 error messages. When the front panel error queue overflows, error messages are deleted beginning with the oldest ones first. When the SCPI error queue overflows, newer error messages are not recorded.

You can scroll through the error messages in reverse order. Refer to the [View Previous Error Message](#) softkey description.

Softkey Location: **Utility > Error Info > View Next Error Message**

View Previous Error Message

If the ERR annunciator is turned on in the display, you have at least one error message stored in the error message queue. Use this softkey to display the newest error message first. Continue pressing this softkey to view additional error messages in order of newest to oldest. Press any front panel key to remove the error message from the display and return to normal signal generator operation.

Softkey Location: **Utility > Error Info > View Previous Error Message**

WCDMA

Press this softkey to set the current catalog type to WCDMA and display the catalog of WCDMA files.

Softkey Location: **Utility > Memory Catalog > Catalog Type > ARB Catalog Types > WCDMA**

White Pixels Screen Test

This softkey is provided for factory use in testing the display. Pressing this softkey sets all of the pixels on the display to white. Pressing the front panel Local key returns the display to normal operation.

Softkey Location: **Utility > Display > White Pixels Screen Test**

5 Memory Structure

This chapter describes the structure of the signal generator's internal memory, and front-panel memory catalog navigation. For information on manipulating files within the internal memory from a remote system, refer to the Programming Guide.

Memory Types

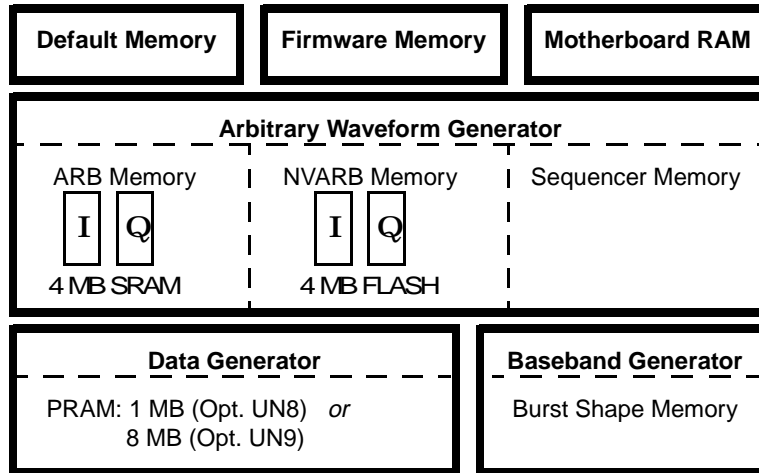

The signal generator's memory, depending on the options present, comprises:

Default Memory

stores FIR filter coefficient data, modulation data, user file bit editor data, and instrument state data.

Firmware Memory

stores the code used by the signal generator to manipulate internal data and the internal hardware.

Motherboard RAM

stores data such as persistent state information, initialized and uninitialized variables, boot ROM, default directories, and default buffer.

Arbitrary Waveform Generator (Option UND) contains:

- ARB memory (RAM-based, volatile) holds the current data for playback using the arbitrary waveform generator.
- NVARB memory (FLASH RAM-based, nonvolatile) stores arbitrary waveform data for subsequent transfer to ARB memory for playback.
- Sequencer memory, which contains data related to waveform segments, waveform sequences, repetition, and marker settings.

Data Generator (Option UN8/9)

contains pattern RAM memory. Data loaded into PRAM is read by the real-time I/Q baseband generator to produce the desired output. PRAM data includes the modulating data bits plus control information such as burst state, EVENT 1 output, and pattern reset.

Baseband Generator (Option UN8/9) contains the burst shape memory.

File Storage – the Memory Catalog

The signal generator's interface for stored files is the memory catalog. You can view, copy, rename and delete files from the memory catalog either from the instrument's front panel or remotely (for information on performing these tasks remotely, see the programming guide).

The Default catalog subcatalogs contain the following information:

Default Catalog	ARB Catalog
Subcatalogs	Subcatalogs
Binary	<i>Used by dual arbitrary waveform generator options</i>
Bit	
FIR	
List	Modulation Catalog
Shape	Subcatalogs
State	<i>Used by both dual arbitrary waveform generator and baseband generator options</i>

Binary	User files, and any other binary files downloaded to the signal generator.
Bit	User file data created/modified using the bit editor or downloaded to the signal generator. Bit files contain a 10-byte header.
FIR	Finite impulse response filter files that contain coefficient values.
List	Data associated with frequency and amplitude sweeps, such as frequency start/stop, dwell time, sweep type/repeat/trigger, point trigger, mode, direction, and trigger out polarity.
Shape	Data associated with specifying burst shape.
State	Data controlling instrument operating state parameters, such as frequency, power level, and mode.

NOTE ARB catalog files and Modulation catalog files are documented in the applicable option user's and programming guide.

Viewing Stored Files

1. Press the Utility hardkey.
2. Press the softkey **Memory Catalog**.
3. Press **Catalog Type**. The default catalog type is **All** (files are listed in alphabetical order).
4. To view a specific catalog type, choose that catalog's softkey.

NOTE Catalogs may display an additional menu of softkeys where you choose the specific subcatalog that you wish to view.

Copying Stored Files

1. Highlight the desired file.
2. Press **Copy File** to open a text editor.
3. Press **Editing Keys > Clear Text**.
4. Input the new file name and press **Enter** to terminate the entry.

Renaming Stored Files

1. Highlight the desired file.
2. Press **More (1 of 2) > Rename File** to open a text editor.
3. Press **Editing Keys > Clear Text**.
4. Input the new file name and press **Enter** to terminate the entry.

Deleting Stored Files

1. Highlight the desired file.
2. Press **Delete File**. The **Confirm Delete** softkey appears.
3. Press **Confirm Delete**.

6 Safety and Regulatory

This chapter provides regulatory declarations, and explanations of caution and warning statements marked on the instrument.

Safety Notes

The following safety notes are used throughout this manual. Familiarize yourself with each of the notes and its meaning before operating this instrument.

CAUTION Caution denotes a hazard. It calls attention to a procedure that, if not correctly performed or adhered to, would result in damage to or destruction of the product. Do not proceed beyond a caution sign until the indicated conditions are fully understood and met.

WARNING **Warning denotes a hazard. It calls attention to a procedure which, if not correctly performed or adhered to, could result in injury or loss of life. Do not proceed beyond a warning note until the indicated conditions are fully understood and met.**

Instrument Markings

The following markings and caution and warning labels are used on the instrument. Be sure to observe all cautions and warnings.

WARNING **No user serviceable parts inside. Refer servicing to qualified personnel.**



The instruction manual symbol. The product is marked with this symbol when it is necessary for the user to refer to the instructions in the manual.



The CE mark is a registered trademark of the European Community (if accompanied by a year, it is the year when the design was proven).



The CSA mark is the Canadian Standards Association safety mark.

LR 57496C



The C-Tick Mark is a trademark registered to the Australian Communications Authority and indicates compliance with the Standard which limits electromagnetic radiation from computing hardware.



This symbol is used to mark the on position of the power line switch.



This symbol is used to mark the standby position of the power line switch.



This symbol indicates that the input power required is AC.

ISM 1-A

This is a symbol of an Industrial Scientific and Medical Group 1 Class A product. (CISPER 11, Clause 4)

ICES/NMB-001

This ISM device complies with Canadian ICES-001. Cet appareil ISM est conforme à la norme NMB-001 du Canada.

General Safety Considerations

WARNING **No operator serviceable parts inside. Refer servicing to qualified personnel. To prevent electrical shock do not remove covers.**

CAUTION Always use the three-prong AC power cord supplied with this product. Failure to ensure adequate earth grounding by not using this cord may cause product damage.

Statement of Compliance

This product has been designed and tested in accordance with IEC Publication 1010, Safety Requirements for Electronic Measuring Apparatus, and has been supplied in a safe condition. The instruction documentation contains information and warnings which must be followed by the user to ensure safe operation and to maintain the product in a safe condition.

Assistance

Product maintenance agreements and other customer assistance agreements are available for Agilent Technologies products. For any assistance, contact your nearest Agilent Technologies sales or service office. (Refer to “[Agilent Technologies Sales and Service Offices](#)” on page 2-21.)

Certification

Agilent Technologies certifies that this product met its published specifications at the time of shipment from the factory. Agilent Technologies further certifies that its calibration measurements are traceable to the United States National Institute of Standards and Technology, to the extent allowed by the Institute's calibration facility, and to the calibration facilities of other International Standards Organization members.

Declaration of Conformity

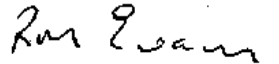
DECLARATION OF CONFORMITY	
According to ISO/IEC Guide 22 and CEN/CENELEC EN 45014	
Manufacturer's Name:	Agilent Technologies, Inc. Agilent Technologies UK Ltd.
Manufacturer's Address:	1400 Fountaingrove Parkway Santa Rosa, CA 95403-1799 USA South Queensferry West Lothian, EH30 9TG Scotland, United Kingdom
Declares that the products	
Product Name:	Signal Generator
Model Number:	E4400B, E4420B, E4421B, E4422B, E4430B, E4431B, E4432B, E4433B, E4423B, E4424B, E4425B, E4426B, E4434B, E4435B, E4436B, E4437B
Product Options:	This declaration covers all options of the above products.
Conform to the following product specifications:	
EMC: IEC 61326-1:1997+A1:1998 / EN 61326-1:1997+A1:1998	
<u>Standard</u>	<u>Limit</u>
CISPR 11:1990 / EN 55011-1991	Group 1, Class A
IEC 61000-4-2:1995+A1998 / EN 61000-4-2:1995	4 kV CD, 8 kV AD
IEC 61000-4-3:1995 / EN 61000-4-3:1995	3 V/m, 80 - 1000 MHz
IEC 61000-4-4:1995 / EN 61000-4-4:1995	0.5 kV sig., 1 kV power
IEC 61000-4-5:1995 / EN 61000-4-5:1996	0.5 kV L-L, 1 kV L-G
IEC 61000-4-6:1996 / EN 61000-4-6:1998	3 V, 0.15 - 80 MHz
IEC 61000-4-11:1994 / EN 61000-4-11:1998	1 cycle, 100%
Safety: IEC 61010-1:1990 + A1:1992 + A2:1995 / EN 61010-1:1993 +A2:1995 CAN/CSA-C22.2 No. 1010.1-92	
Supplementary Information: The products herewith comply with the requirements of the Low Voltage Directive 73/23/EEC and the EMC Directive 89/336/EEC and carry the CE-marking accordingly.	
	
Greg Pfeiffer/Quality Engineering Manager Santa Rosa, 22 Mar. 2000	R. M. Evans/Quality Manager South Queensferry, 29 Mar. 2000
For further information, please contact your local Agilent Technologies sales office, agent or distributor.	

Compliance with German Noise Requirements

This is to declare that this instrument is in conformance with the German Regulation on Noise Declaration for Machines (Laermangabe nach der Maschinenlaermrrordnung -3.GSGV Deutschland).

Acoustic Noise Emission/Geraeuschemission	
LpA < 70 dB	LpA < 70 dB
Operator position	am Arbeitsplatz
Normal position	normaler Betrieb
per ISO 7779	nach DIN 45635 t.19

Symbols

Points softkey, [4-96](#)
ΦM annunciator, [3-9](#)
ΦM hardkey, [4-67](#)
ΦM softkeys
 ΦM Dev, [4-68](#)
 ΦM Dev Couple Off On, [4-69](#)
 ΦM Off On, [4-69](#)
 ΦM Path 1 2, [4-70](#)
 ΦM Rate, [4-70](#)
 ΦM Source, [4-71](#)
 ΦM Start Rate, [4-71](#)
 ΦM Stop Rate, [4-72](#)
 ΦM Sweep Time, [4-72](#)
 ΦM Sweep Trigger, [4-72](#)
 ΦM Tone 1 Rate, [4-73](#)
 ΦM Tone 2 Ampl Percent Of Peak, [4-73](#)
 ΦM Tone 2 Rate, [4-73](#)
 ΦM Waveform, [4-74](#)

Numerics

10 MHz
 IN connector, [3-14](#)
 OUT connector, [3-14](#)
321.4 MHz IN connector, [3-19](#)

A

AC power receptacle, [3-13](#)
AC symbol, [6-3](#)
active entry area, [3-9](#)
Add Comment To Seq[nn] Reg[nn] softkey, [4-91](#)
Adjust Phase softkey, [4-34](#)
air flow, [1-4](#)
ALC
 annunciator, OFF, [3-9](#), [4-14](#), [4-43](#)
 softkeys
 BW Normal Narrow, [4-13](#)
 Off On, [4-14](#), [4-42](#)
Alt Ampl Delta softkey, [4-15](#)
Alt Ampl Off On softkey, [4-15](#)
Alt Ampl Trigger softkey, [4-15](#)
ALT PWR IN connector, [3-15](#)
Alternate Amplitude
 softkey, [4-14](#)
altitude requirements, [1-4](#)
AM, [4-2](#)
AM annunciator, [3-9](#)
AM depth
 setting, [2-5](#)
AM Depth Couple Off On softkey, [4-2](#)
AM Depth softkey, [4-2](#)
AM hardkey, [4-2](#)
AM Off On softkey, [4-3](#)
AM Path 1 2 softkey, [4-3](#)
AM Path 1 2 WB softkey, [4-3](#)
AM rate
 setting, [2-6](#)
AM Rate softkey, [4-4](#)
AM Source softkey, [4-4](#)
AM Start Rate softkey, [4-5](#)
AM Stop Rate softkey, [4-5](#)
AM Sweep Time softkey, [4-6](#)
AM sweep trigger
 bus, [4-7](#)
 external, [4-8](#)
 immediate, [4-9](#)
 trigger key, [4-12](#)
AM Sweep Trigger softkey, [4-6](#)
AM Tone 1 Rate softkey, [4-6](#)
AM Tone 2 Ampl Ratio Percent Of Peak softkey, [4-7](#)
AM Tone 2 Rate softkey, [4-7](#)
AM Waveform softkey, [4-7](#)
Ampl hardkey, [4-13](#)
Ampl Offset softkey, [4-16](#)
Ampl Ref Off On softkey, [4-16](#)
Ampl Ref Set softkey, [4-16](#)
Ampl softkey, [4-96](#)
Ampl Start softkey, [4-97](#)
Ampl Stop softkey, [4-97](#)
amplitude display area, [3-8](#)
Amplitude hardkey, [3-6](#), [4-19](#)
amplitude modulation, [4-2](#)
 setting up, [2-5](#), [4-3](#)
 turning on, [2-6](#)
amplitude offset, [4-16](#)
 setting, [2-4](#)
amplitude offset, setting, [2-4](#)
amplitude reference, [4-16](#)
 setting, [2-4](#)
amplitude sweep, [4-96](#)
annunciators, [3-9](#), [4-4](#)
 ΦM, [3-9](#)
 ALC OFF, [3-9](#), [4-14](#), [4-43](#)
 AM, [3-9](#)
 ARMED, [3-9](#)
 ATTEN HOLD, [3-9](#)
 BERT, [3-9](#)
 digital modulation, [3-9](#)
 ENVLP, [3-9](#)
 ERR, [3-10](#)

- EXT REF, 3-10
 - EXT1 HI, 3-10
 - EXT1 LO, 3-10, 4-4
 - EXT2 HI, 3-10
 - EXT2 LO, 3-10, 4-4
 - FM, 3-10
 - I/Q, 3-10
 - L, 3-10
 - MOD OFF, 3-10
 - MOD ON, 3-10
 - OVEN COLD, 3-10
 - PULSE, 3-10
 - R, 3-10
 - RF OFF, 3-10
 - S, 3-10
 - SWEEP, 3-10
 - T, 3-11
 - UNLEVEL, 3-11
 - UNLOCK, 3-11
 - ARB Catalog Types softkey, 4-111
 - ARB memory, 5-2
 - ARB softkey, 4-111
 - ARMED annunciator, 3-9
 - arrow keys, 3-4, 4-20
 - assistance, 6-6
 - ATTEN HOLD annunciator, 3-9
 - Atten Hold Off On softkey, 4-17
 - attenuator
 - hold, 4-17
 - number of cycles, 4-117
 - automatic leveling control, 4-14
 - AUXILIARY INTERFACE connector, 3-13
- B**
- backspace key, 4-66
 - BASEBAND GEN REF IN connector, 3-17
 - baud rate, 4-133
 - BER CLK IN connector, 3-19
 - BER DATA IN, 3-19
 - BER DATA IN connector, 3-19
 - BER ERR OUT connector, 3-18
 - BER GATE IN connector, 3-19
 - BER MEAS END connector, 3-18
 - BER NO DATA connector, 3-18
 - BER SYNC LOSS connector, 3-19
 - BER TEST OUT connector, 3-18
 - BERT annunciator, 3-9
 - Binary softkey, 4-111
 - Bit softkey, 4-111
 - Black Pixels Screen Test softkey, 4-112
 - Brightness softkey, 4-112
 - Burst Envelope Off On softkey, 4-43
 - BURST GATE IN connector, 3-15
 - Burst Gate In Polarity Neg Pos softkey, 4-112
 - burst shape memory, 5-2
 - burst source
 - internal, 4-48
 - Burst Source softkey, 4-43
 - Bus softkey, 4-7, 4-22, 4-51, 4-74, 4-97
- C**
- Calibrate Selected Items softkey, 4-112
 - Calibration Type User Full softkey, 4-44
 - Canadian Standards Association, 6-3
 - carrier frequency (amplitude modulation)
 - setting, 2-5
 - carrier frequency (frequency modulation)
 - setting, 2-7
 - Catalog Type softkey, 4-113
 - catalogs
 - copying files, 5-4
 - deleting files, 5-4
 - renaming files, 5-4
 - viewing files, 5-3
 - caution sign, 6-2
 - CDMA softkey, 4-113
 - CE mark, 6-3
 - certificate
 - license key, 2-15
 - certification, 6-7
 - specifications, 6-7
 - changing signs, 4-66
 - cleaning, 1-4
 - Clear Error Queue(s) softkey, 4-113
 - Clear Text softkey, 4-92, 4-114
 - COHERENT CARRIER OUT connector, 3-15
 - compliance
 - statement of, 6-5
 - compliance with German noise requirements, 6-9
 - Configure List Sweep softkey, 4-97
 - Configure Step Sweep softkey, 4-98
 - configuring a list sweep using step sweep data, 2-10
 - connectors, 3-13–3-19
 - 10 MHz IN, 3-14
 - 10 MHz OUT, 3-14
 - 321.4 MHz IN, 3-19
 - ALT PWR IN, 3-15
 - AUXILIARY INTERFACE, 3-13
 - BASEBAND GEN REF IN, 3-17
 - BER CLK IN, 3-19

- BER DATA IN, 3-19
 - BER ERR OUT, 3-18
 - BER GATE IN, 3-19
 - BER MEAS END, 3-18
 - BER NO DATA, 3-18
 - BER SYNC LOSS, 3-19
 - BER TEST OUT, 3-18
 - BURST GATE IN, 3-15
 - COHERENT CARRIER OUT, 3-15
 - DATA, 3-6
 - DATA CLK OUT, 3-14
 - DATA CLOCK, 3-7
 - DATA OUT, 3-14
 - EVENT 1, 3-16
 - EVENT 2, 3-16
 - EXT 1 INPUT, 3-3
 - EXT 2 INPUT, 3-3
 - HP-IB, 3-13
 - I INPUT, 3-5
 - I OUT, 3-17
 - LF OUTPUT, 3-3
 - PATTERN TRIG IN, 3-15
 - PULSE IN, 3-7
 - Q INPUT, 3-5
 - Q OUT, 3-18
 - RF OUTPUT, 3-4
 - RS-232, 3-13
 - SWEEP OUT, 3-14
 - SYMBOL SYNC, 3-7
 - SYMBOL SYNC OUT, 3-13
 - TRIGGER IN, 3-14
 - TRIGGER OUT, 3-14
 - contrast decrease hardkey, 3-4
 - contrast increase hardkey, 3-4
 - cooling holes, 1-4
 - Copy File softkey, 4-114
 - coupling
 - FM deviation, 4-25
 - creating a step sweep and a list sweep, 2-9
 - CSA mark, 6-3
- D**
- DATA CLK OUT connector, 3-14
 - DATA CLOCK input connector, 3-7
 - Data Clock Out Polarity Neg Pos softkey, 4-115
 - Data Clock Polarity Neg Pos softkey, 4-115
 - DATA input connector, 3-6
 - DATA OUT connector, 3-14
 - Data Out Polarity Neg Pos softkey, 4-115
 - Data Polarity Neg Pos softkey, 4-116
 - DATA/CLK/SYNC Rear Outputs Off On softkey, 4-115
 - DC softkey, 4-51
 - DCΦM calibration, 4-74
 - DCFM/DCΦM Cal softkey, 4-22, 4-74
 - Declaration of Conformity, 6-8
 - default memory, 5-2
 - Delete All List Files softkey, 4-116
 - Delete All Regs in Seq [n], 4-86, 4-92
 - Delete All Sequences softkey, 4-86, 4-92
 - Delete File softkey, 4-98, 4-116
 - Delete Item softkey, 4-98
 - Delete Row softkey, 4-98
 - Delete Seq[n] Reg[nn], 4-87, 4-93
 - Diagnostic Info softkey, 4-117
 - digit keys, 4-66
 - digital modulation annunciators, 3-9
 - display
 - active entry area, 3-9
 - amplitude area, 3-8
 - annunciators, 3-9
 - brightness, 4-112
 - error message area, 3-8
 - frequency area, 3-8
 - location, 3-5
 - modulation status, 4-126
 - number of hours lit, 4-117
 - text area, 3-9
 - display annotation, 3-8
 - display contrast, 1-5
 - display contrast decrease hardkey, 3-4, 4-21
 - display contrast increase, 3-4
 - display contrast increase hardkey, 3-4, 4-21
 - display light, 1-5
 - Display softkey, 4-117
 - DMOD softkey, 4-118
 - Do Power Search softkey, 4-17, 4-44
 - down arrow key, 4-20
 - Dual Sine softkey, 4-8, 4-22, 4-52, 4-74
 - DWCDMA softkey, 4-118
 - dwelt time
 - incorrect, 2-18
 - dwelt time, step sweep, 4-105
 - Dwell Type List Step softkey, 4-99
- E**
- echo off/on, 4-133
 - Edit Item softkey, 4-99
 - Editing Keys softkey, 4-93, 4-118
 - Editing Mode Insert Replace softkey, 4-93, 4-118
 - electrical requirements, 1-3
 - enabling options, 2-13

- environmental requirements, 1-3
 - ENVLP annunciator, 3-9
 - ERR annunciator, 3-10
 - Error Info softkey, 4-119
 - error message area, 3-8
 - error messages
 - where displayed, 3-8
 - European Community trademark, 6-3
 - EVENT 1 connector, 3-16
 - Event 1 Polarity Neg Pos softkey, 4-119
 - EVENT 2 connector, 3-16
 - Event 2 Polarity Neg Pos softkey, 4-119
 - examples
 - enabling options, 2-13
 - Execute Cal softkey, 4-44
 - Ext 1 AC-Coupled softkey, 4-8, 4-23, 4-75
 - Ext 1 DC-Coupled softkey, 4-8, 4-23, 4-75
 - EXT 1 INPUT connector, 3-3
 - Ext 2 AC-Coupled softkey, 4-9, 4-24, 4-76
 - Ext 2 DC-Coupled softkey, 4-9, 4-24, 4-76
 - EXT 2 INPUT connector, 3-3
 - Ext I/Q Phase Polarity Normal Invert softkey, 4-45
 - Ext I/Q softkey, 4-45
 - Ext Pos softkey, 4-99
 - EXT REF annunciator, 3-10
 - Ext softkey, 4-8, 4-23, 4-52, 4-74
 - Ext1 DC softkey, 4-44
 - EXT1 HI annunciator, 3-10, 4-4
 - EXT1 LO annunciator, 3-10, 4-4
 - Ext2 DC-Coupled softkey, 4-82
 - EXT2 HI annunciator, 3-10, 4-4
 - EXT2 LO annunciator, 3-10, 4-4
- F**
- Fast Pulse Off On softkey, 4-82
 - FCDMA softkey, 4-119
 - files
 - copying, 5-4
 - deleting, 5-4
 - renaming, 5-4
 - viewing, 5-3
 - FIR softkey, 4-119
 - firmware memory, 5-2
 - firmware revision, 4-117
 - FLASH RAM-based memory, 5-2
 - FM, 4-22
 - FM annunciator, 3-10
 - FM Dev Couple Off On softkey, 4-25
 - FM Dev softkey, 4-25
 - FM deviation, 4-25
 - setting, 2-7
 - FM deviation coupling, 4-25
 - FM Φ M Normal High BW softkey, 4-76
 - FM Φ M softkey, 4-24
 - FM hardkey, 4-22
 - FM Off On softkey, 4-26
 - FM Path 1 2 softkey, 4-26
 - FM rate, 4-27
 - setting, 2-8
 - FM Rate softkey, 4-27
 - FM Source softkey, 4-27
 - FM Start Rate softkey, 4-28
 - FM Stop Rate softkey, 4-28
 - FM Sweep Time softkey, 4-28
 - FM sweep trigger
 - bus, 4-22
 - external, 4-23
 - immediate, 4-30
 - trigger key, 4-32
 - FM Sweep Trigger softkey, 4-29
 - FM Tone 1 Rate softkey, 4-29
 - FM Tone 2 Ampl Percent Of Peak softkey, 4-29
 - FM Tone 2 Rate softkey, 4-30
 - FM Waveform softkey, 4-30
 - Freq hardkey, 4-34
 - Freq Multiplier softkey, 4-35
 - Freq Offset softkey, 4-35
 - Freq Ref Off On softkey, 4-36
 - Freq Ref Set softkey, 4-36
 - Freq softkey, 4-99
 - Freq Start softkey, 4-100
 - Freq Stop softkey, 4-100
 - Freq&Ampl softkey, 4-100
 - frequency
 - multiplying, 4-35
 - offset, 4-35
 - reference, 4-36
 - setting, 2-2
 - frequency and amplitude sweep, 4-100
 - frequency display area, 3-8
 - Frequency hardkey, 3-6, 4-38
 - frequency modulation, 4-22
 - setting up, 2-7
 - turning on, 2-8
 - frequency multiplier, 4-35
 - frequency offset
 - setting, 2-3

frequency offset, setting, [2-3](#)
frequency output, [4-38](#)
frequency reference
 setting, [2-3](#)
frequency sweep, [4-99](#)
front handles
 installation, [1-2](#)
front panel knob, [3-5](#)
front panel overview, [3-2](#)
FSK softkey, [4-119](#)
Function Generator softkey, [4-52](#)
FWCDMA softkey, [4-120](#)

G

German Regulation on Noise Declaration for
 Machines, [6-9](#)
Goto Bottom Row softkey, [4-100](#)
Goto Middle Row softkey, [4-101](#)
Goto Row softkey, [4-101](#)
Goto Top Row softkey, [4-101](#)

H

handles, front, [1-2](#)
hardkey descriptions, [4-1](#)
hardkeys, [3-4](#), [4-20](#)
 ΦM, [4-67](#)
 AM, [4-2](#)
 Ampl, [4-13](#)
 Amplitude, [3-6](#), [4-19](#)
 arrow, [3-4](#)
 contrast decrease, [3-4](#)
 contrast increase, [3-4](#)
 display contrast decrease, [3-4](#), [4-21](#)
 display contrast increase, [4-21](#)
 FM, [4-22](#)
 Freq, [4-34](#)
 Frequency, [3-6](#), [4-38](#)
 Help, [3-3](#), [4-39](#)
 Hold, [3-5](#), [4-40](#)
 I/Q, [4-42](#)
 Incr Set, [3-6](#), [4-41](#)
 LF Out, [4-51](#)
 Local, [4-63](#)
 menus, [3-6](#)
 Mod On/Off, [3-3](#), [4-64](#)
 Mode, [4-65](#)
 numeric, [3-4](#)
 Preset, [3-4](#), [4-81](#)
 Pulse, [4-82](#)
 Recall, [3-6](#), [4-86](#)

 Return, [4-89](#)
 RF On/Off, [3-4](#), [4-90](#)
 Save, [3-6](#), [4-91](#)
 Sweep/List, [4-96](#)
 Trigger, [3-3](#), [4-109](#)
 up arrow, [4-20](#)
 Utility, [4-111](#)
hardware option
 enabling, [2-13](#)
Hardware Options softkey, [4-120](#)
Help hardkey, [3-3](#), [4-39](#)
help mode
 changing, [4-120](#)
 turning off, [2-18](#)
Help Mode Single Cont softkey, [4-120](#)
High Crest Mode Off On softkey, [4-45](#)
Hold hardkey, [3-5](#), [4-40](#)
HP sales and service offices, [2-21](#)
HP8648A/B/C/D softkey, [4-121](#)
HP8656B,8657A/B softkey, [4-121](#)
HP8657D NADC softkey, [4-121](#)
HP8657D PDC softkey, [4-122](#)
HP8657J PHS softkey, [4-122](#)
HP-IB address, [1-6](#)
HP-IB Address softkey, [4-122](#)
HP-IB connector, [3-13](#)
HP-IB/RS-232 softkey, [4-123](#)
humidity requirements, [1-4](#)

I

I INPUT connector, [3-5](#)
I Offset softkey, [4-46](#)
I OUT connector, [3-17](#)
I/Q
 external source, [4-45](#)
 internal source, [4-48](#)
I/Q Adjustments Off On softkey, [4-46](#)
I/Q Adjustments softkey, [4-46](#)
I/Q annunciator, [3-10](#)
I/Q calibration, [4-44](#)
 start frequency, [4-50](#)
I/Q Calibration softkey, [4-46](#)
I/Q Gain softkey, [4-47](#)
I/Q hardkey, [4-42](#)
I/Q modulation, [4-47](#)
I/Q Off On softkey, [4-47](#)
I/Q softkey, [4-124](#)
I/Q Source softkey, [4-47](#)
IEC Publication 1010, [6-5](#)

Immediate softkey, [4-9](#), [4-30](#), [4-52](#), [4-77](#), [4-102](#)
Incr Set hardkey, [3-6](#), [4-41](#)
increment setting, [4-41](#)
indoor use, [1-4](#)
input connectors, [3-19](#)
 10 MHz IN, [3-14](#)
 321.4 MHz IN, [3-19](#)
 AUXILIARY INTERFACE, [3-13](#)
 BASEBAND GEN REF IN, [3-17](#)
 BER CLK IN, [3-19](#)
 BER GATE IN, [3-19](#)
 BURST GATE IN, [3-15](#)
 DATA, [3-6](#)
 DATA CLOCK, [3-7](#)
 EXT 1 INPUT, [3-3](#)
 EXT 2 INPUT, [3-3](#)
 HP-IB, [3-13](#)
 I INPUT, [3-5](#)
 line power, [3-13](#)
 PATTERN TRIG IN, [3-15](#)
 PULSE IN, [3-7](#)
 Q INPUT, [3-5](#)
 RS-232, [3-13](#)
 SYMBOL SYNC, [3-7](#)
 TRIGGER IN, [3-14](#)
Insert Item softkey, [4-102](#)
Insert Row softkey, [4-102](#)
installation, [1-2](#)
Installed Board Info softkey, [4-123](#)
instruction manual symbol, [6-3](#)
Instrument Adjustments softkey, [4-123](#)
Instrument Info/Help Mode softkey, [4-124](#)
instrument markings, [6-3](#)
instrument state
 saving and recalling, [2-12](#)
Int Burst softkey, [4-48](#)
Int I/Q softkey, [4-48](#)
Internal Modulation softkey, [4-53](#)
Internal Pulse softkey, [4-83](#)
internal reference oscillator adjustment, [4-130](#)
Internal softkey, [4-10](#), [4-30](#), [4-77](#)
Internal Square softkey, [4-83](#)
internally-generated amplitude modulation
 setting, [2-5](#)
internally-generated frequency modulation
 setting up, [2-7](#)
inverse video, [1-5](#)
Inverse Video Off On softkey, [4-124](#)
IQ calibration
 stop frequency, [4-50](#)
ISM 1-A symbol, [6-3](#)

K

key
 license, [2-15](#)
key descriptions, [4-1](#)
keypad, numeric, [3-4](#)
kits, [1-2](#)
 front handles, [1-2](#)
knob, [3-5](#)

L

L annunciator, [3-10](#)
language, [1-6](#)
LED, [4-80](#)
 green, [4-80](#)
LEDs
 line power, [3-5](#)
 standby, [3-5](#)
left arrow key, [4-20](#)
LF Out Amplitude softkey, [4-53](#)
LF Out Freq softkey, [4-53](#)
LF Out hardkey, [4-51](#)
LF Out Off On softkey, [4-54](#)
LF Out Period softkey, [4-54](#)
LF Out Source softkey, [4-55](#)
LF Out Start Freq softkey, [4-55](#)
LF Out Stop Freq softkey, [4-56](#)
LF Out Sweep Time softkey, [4-56](#)
LF Out Sweep Trigger softkey, [4-57](#)
LF Out Tone 1 Freq softkey, [4-57](#)
LF Out Tone 2 Ampl % Of Peak softkey, [4-58](#)
LF Out Tone 2 Freq softkey, [4-58](#)
LF Out Waveform softkey, [4-59](#)
LF Out Width softkey, [4-59](#)
LF output
 DC waveform, [4-51](#)
 incorrect signal, [2-18](#)
LF OUTPUT connector, [3-3](#)
LF output source
 internal, [4-53](#)
LF output sweep trigger
 bus, [4-51](#)
 external, [4-52](#)
 immediate, [4-52](#)
 trigger key, [4-62](#)
license key, [2-15](#)
light bulb, [1-5](#)
line power LED, [3-5](#)
line settings, [1-3](#)
List softkey, [4-124](#)

list sweep
 configuring using step sweep data, 2-10
 creating, 2-9
 turning on for a single sweep, 2-11
list sweep points
 editing, 2-10
list sweep, creating, 2-9
listen mode annunciator, 3-10
Load From Selected File softkey, 4-102
Load List From Step Sweep softkey, 4-103
Load/Store softkey, 4-103
Local, 3-4
Local hardkey, 3-4, 4-63
locked up, 2-19
low frequency generator, 4-51

M

maintenance agreements, 6-6
Manual Mode Off On softkey, 4-103
Manual Point softkey, 4-103
MCDMA softkey, 4-124
MDMOD softkey, 4-125
MDWCDMA softkey, 4-125
memory
 ARB, 5-2
 burst shape, 5-2
 default, 5-2
 firmware, 5-2
 FLASH RAM-based, 5-2
 motherboard RAM, 5-2
 nonvolatile, 5-2
 NVARB, 5-2
 pattern RAM, 5-2
 RAM-based, 5-2
 volatile, 5-2
memory catalog
 copying files, 5-4
 deleting files, 5-4
 renaming files, 5-4
 viewing files, 5-3
Memory Catalog softkey, 4-124
menu hardkeys, 3-6
MFCDMA softkey, 4-125
MFWCDMA softkey, 4-125
MOD OFF annunciator, 3-10
MOD ON annunciator, 3-10
Mod On/Off hardkey, 3-3, 4-64
Mod Status Info Off On softkey, 4-126
Mode 1 Optimize <10kHz Offset softkey, 4-36

Mode 2 Optimize >10kHz Offset softkey, 4-36
Mode hardkey, 4-65
model number, 4-117
Modify License Key softkey, 4-125
modulation
 annunciators, 3-9, 3-10
 none, 2-17
 turning on/off, 4-64
Modulation Catalog Types softkey, 4-126
modulation status display, 4-126
motherboard RAM, 5-2
MTONE softkey, 4-126
multiplying frequency, 4-35

N

Noise softkey, 4-10, 4-31, 4-59, 4-77
nonvolatile memory, 5-2
numeric keypad, 3-4, 4-66
NVARB memory, 5-2
NVARB softkey, 4-126

O

Off softkey, 4-104, 4-126
offset, 4-35
operation verification, 1-7
operational problems, 2-16
operator's check, 1-7
Optimize Φ Noise softkey, 4-37
options
 enabling, 2-13
 not working, 2-16
output
 frequency, 4-38
 power, 4-19
output connectors
 10 MHz OUT, 3-14
 AUXILIARY INTERFACE, 3-13
 BER ERR OUT, 3-18
 BER MEAS END, 3-18
 BER NO DATA, 3-18
 BER SYNC LOSS, 3-19
 BER TEST OUT, 3-18
 COHERENT CARRIER OUT, 3-15
 DATA CLK OUT, 3-14
 DATA OUT, 3-14
 EVENT 1, 3-16
 EVENT 2, 3-16
 HP-IB, 3-13
 I OUT, 3-17

- LF OUTPUT, 3-3
 - Q OUT, 3-18
 - RF OUTPUT, 3-4
 - RS-232, 3-13
 - SWEEP OUT, 3-14
 - SYMBOL SYNC OUT, 3-13
 - TRIGGER OUT, 3-14
 - OVEN COLD annunciator, 3-10
- P**
- pace, 4-133
 - Page Down softkey, 4-104, 4-127
 - Page Up softkey, 4-104, 4-127
 - pattern RAM, 5-2
 - PATTERN TRIG IN connector, 3-15
 - Pattern Trigger In Polarity Neg Pos softkey, 4-127
 - phase modulation, 4-67
 - source, 4-71
 - start rate, 4-71
 - stop rate, 4-72
 - sweep time, 4-72
 - sweep trigger, 4-72
 - tone 1 rate, 4-73
 - tone 2 amplitude percent of peak, 4-73
 - tone 2 rate, 4-73
 - turning off/on, 4-69
 - waveform, 4-74
 - phase modulation deviation, 4-68
 - phase modulation deviation coupling, 4-69
 - phase modulation rate, 4-70
 - phase modulation sweep trigger
 - bus, 4-74
 - external, 4-74
 - immediate, 4-77
 - trigger key, 4-79
 - Phase Ref Set softkey, 4-37
 - phase, changing, 4-34
 - PN9 Mode Preset Normal Quick softkey, 4-127
 - point trigger, 4-97, 4-99, 4-102, 4-107
 - Point Trigger softkey, 4-104
 - power cord, 1-3
 - power cycles, number of, 4-117
 - power level (amplitude modulation)
 - setting, 2-5
 - power level (frequency modulation)
 - setting, 2-7
 - power levels
 - setting, 2-2
 - Power On Last Preset softkey, 4-128
 - power on symbol, 6-3
 - Power On/Preset softkey, 4-128
 - power output, 4-19
 - power receptacle, 3-13
 - power search, 4-17, 4-44
 - Power Search Manual Auto softkey, 4-18, 4-48
 - Power Search Reference Fixed Modulated softkey, 4-18
 - Power Search softkey, 4-18
 - power supply
 - shut down, 2-17
 - power switch, 3-5, 4-80
 - power, setting, 2-2
 - PRAM, 5-2
 - preparing for use, 1-1
 - Preset hardkey, 3-4, 4-81
 - Preset Language softkey, 4-129
 - Preset List softkey, 4-105
 - Preset Normal User softkey, 4-129
 - problems with operation, 2-16
 - Proceed With Reconfiguration softkey, 4-129
 - programming language, 1-6
 - PULSE annunciator, 3-10
 - Pulse hardkey, 4-82
 - PULSE IN connector, 3-7
 - pulse modulation, 4-82
 - internal rectangular, 4-83
 - internal squarewave, 4-83
 - Pulse Off On softkey, 4-83
 - Pulse Rate softkey, 4-84
 - Pulse softkey, 4-60
 - Pulse Source softkey, 4-84
 - Pulse Width softkey, 4-85
 - pulsed LF output, 4-60
- Q**
- Q INPUT connector, 3-5
 - Q Offset softkey, 4-49
 - Q OUT connector, 3-18
 - Quadrature Skew softkey, 4-49
- R**
- R annunciator, 3-10
 - rack mount flanges, installation, 1-2
 - RAM-based memory, 5-2
 - Ramp softkey, 4-10, 4-31, 4-60
 - RCDMA softkey, 4-130
 - rear panel overview, 3-12

Recall hardkey, 3-6, 4-86
Recall Ref Osc Setting softkey, 4-130
Recall Reg softkey, 4-87
recalling instrument states, 2-12
Receive Pace None Xon softkey, 4-130
Ref Osc Coarse softkey, 4-118, 4-130
Ref Osc Fine softkey, 4-131
Ref Oscillator Source Auto Off On softkey, 4-37
Reference Oscillator Adjustment softkey, 4-130
registers
 contents incorrect, 2-17
 empty, 2-17
Remote Language softkey, 4-131
remote operation
 annunciator, 3-10
Rename File softkey, 4-131
repair, returning your instrument, 2-20
Reset RS-232 softkey, 4-132
Restore Default Signal Polarities softkey, 4-132
Return, 3-4
Return hardkey, 3-4, 4-89
returning your instrument, 2-20
Reverse Power Protection Normal HP8648 softkey, 4-132
reverse power protection trips, 4-117
Revert to Default Cal Settings softkey, 4-49
RF frequency
 setting, 2-2
RF OFF annunciator, 3-10
RF On/Off hardkey, 3-4, 4-90
RF output
 low, 2-16
 none, 2-16
RF OUTPUT connector, 3-4
RF output power level
 setting, 2-3
right arrow key, 4-20
RS-232 Baud Rate softkey, 4-133
RS-232 connector, 3-13
RS-232 Echo Off On softkey, 4-133
RS-232 Pace softkey, 4-133
RS-232 Timeout softkey, 4-133
RTS On softkey, 4-134
RTS/CTS Pacing softkey, 4-134
RTS/CTS softkey, 4-134
RWCdma softkey, 4-134

S

S annunciator, 3-10
safety, 6-1
safety notes, 6-2
sales and service offices, 2-21
Save hardkey, 3-6, 4-91
Save Seq[n] Reg[nn], 4-94
Save User Preset softkey, 4-135
saving and recalling an instrument state, 2-12
saving instrument states, 2-12
SCPI softkey, 4-135
screen saver, 1-5
Screen Saver Delay softkey, 4-135
Screen Saver Mode softkey, 4-136
Screen Saver Off On softkey, 4-136
Select Item softkey, 4-136
Select Reg softkey, 4-94
Select Seq softkey, 4-88, 4-95
Seq softkey, 4-137
serial number, 4-117
service request annunciator, 3-10
setting a frequency reference and frequency offset, 2-3
setting AM depth, 2-5
setting AM rate, 2-6
setting an amplitude reference and amplitude offset, 2-4
setting carrier frequency (amplitude modulation), 2-5
setting carrier frequency (frequency modulation), 2-7
setting FM deviation, 2-7
setting FM rate, 2-8
setting frequency and power levels, 2-2
setting internally-generated amplitude modulation, 2-5
setting power level (amplitude modulation), 2-5
setting power level (frequency modulation), 2-7
setting RF frequency, 2-2
setting the RF output power level, 2-3
setting up internally-generated frequency modulation, 2-7
Shape softkey, 4-137
shipment
 checking, 1-2
signal generation
 installation, 1-2
Sine softkey, 4-10, 4-31, 4-60, 4-77
Single Sweep softkey, 4-105
softkey descriptions, 4-1

- softkey labels, 3-8
- softkeys
 - # Points, 4-96
 - ΦM Dev, 4-68
 - ΦM Dev Couple Off On, 4-69
 - ΦM Off On, 4-69
 - ΦM Path 1 2, 4-70
 - ΦM Rate, 4-70
 - ΦM Source, 4-71
 - ΦM Start Rate, 4-71
 - ΦM Stop Rate, 4-72
 - ΦM Sweep Time, 4-72
 - ΦM Sweep Trigger, 4-72
 - ΦM Tone 1 Rate, 4-73
 - ΦM Tone 2 Ampl Percent Of Peak, 4-73
 - ΦM Tone 2 Rate, 4-73
 - ΦM Waveform, 4-74
 - Add Comment To Seq[n] Reg[nn], 4-91
 - Adjust Phase, 4-34
 - ALC BW Normal Narrow, 4-13
 - ALC Off On, 4-14, 4-42
 - Alt Ampl Delta, 4-15
 - Alt Ampl Off On, 4-15
 - Alt Ampl Trigger, 4-15
 - Alternate Amplitude, 4-14
 - AM Depth, 4-2
 - AM Depth Couple Off On, 4-2
 - AM Off On, 4-3
 - AM Path 1 2, 4-3
 - AM Path 1 2 WB, 4-3
 - AM Rate, 4-4
 - AM Source, 4-4
 - AM Start Rate, 4-5
 - AM Stop Rate, 4-5
 - AM Sweep Time, 4-6
 - AM Sweep Trigger, 4-6
 - AM Tone 1 Rate, 4-6
 - AM Tone 2 Ampl Percent Of Peak, 4-7
 - AM Tone 2 Rate, 4-7
 - AM Waveform, 4-7
 - Ampl, 4-96
 - Ampl Offset, 4-16
 - Ampl Ref Off On, 4-16
 - Ampl Ref Set, 4-16
 - Ampl Start, 4-97
 - Ampl Stop, 4-97
 - ARB, 4-111
 - ARB Catalog Types, 4-111
 - Atten Hold Off On, 4-17
 - Binary, 4-111
 - Bit, 4-111
 - Black Pixels Screen Test, 4-112
 - Brightness, 4-112
 - Burst Envelope Off On, 4-43
 - Burst Gate In Polarity Neg Pos, 4-112
 - Burst Source, 4-43
 - Bus, 4-7, 4-22, 4-51, 4-74, 4-97
 - Calibrate Selected Items, 4-112
 - Calibration Type User Full, 4-44
 - Catalog Type, 4-113
 - CDMA, 4-113
 - Clear Error Queue(s), 4-113
 - Clear Text, 4-92, 4-114
 - Configure List Sweep, 4-97
 - Configure Step Sweep, 4-98
 - Copy File, 4-114
 - Data Clock Out Polarity Neg Pos, 4-115
 - Data Clock Polarity Neg Pos, 4-115
 - Data Out Polarity Neg Pos, 4-115
 - Data Polarity Neg Pos, 4-116
 - DATA/CLK/SYNC Rear Outputs Off On, 4-115
 - DC, 4-51
 - DCFM/DCΦM Cal, 4-22, 4-74
 - Delete All List Files, 4-116
 - Delete All Sequences, 4-86, 4-92
 - Delete File, 4-98, 4-116
 - Delete Item, 4-98
 - Delete Row, 4-98
 - Diagnostic Info, 4-117
 - Display, 4-117
 - DMOD, 4-118
 - Do Power Search, 4-17, 4-44
 - Dual Sine, 4-8, 4-22, 4-52, 4-74
 - DWCDMA, 4-118
 - Dwell Type List Step, 4-99
 - Edit Item, 4-99
 - Editing Keys, 4-93, 4-118
 - Editing Mode Insert Replace, 4-93, 4-118
 - Error Info, 4-119
 - Event 1 Polarity Neg Pos, 4-119
 - Event 2 Polarity Neg Pos, 4-119
 - Execute Cal, 4-44
 - Ext, 4-8, 4-23, 4-52, 4-74
 - Ext 1 AC-Coupled, 4-8, 4-23, 4-75
 - Ext 1 DC-Coupled, 4-8, 4-23, 4-75
 - Ext 2 AC-Coupled, 4-9, 4-24, 4-76
 - Ext 2 DC-Coupled, 4-9, 4-24, 4-76
 - Ext I/Q, 4-45
 - Ext I/Q Phase Polarity Normal Invert, 4-45
 - Ext Pos, 4-99
 - Ext1 DC, 4-44
 - Ext2 DC-Coupled, 4-82
 - Fast Pulse Off On, 4-82
 - FCDMA, 4-119

- FIR, [4-119](#)
- FM Dev, [4-25](#)
- FM Dev Couple Off On, [4-25](#)
- FM Φ M, [4-24](#)
- FM Φ M Normal High BW, [4-76](#)
- FM Off On, [4-26](#)
- FM Path 1 2, [4-26](#)
- FM Rate, [4-27](#)
- FM Source, [4-27](#)
- FM Start Rate, [4-28](#)
- FM Stop Rate, [4-28](#)
- FM Sweep Time, [4-28](#)
- FM Sweep Trigger, [4-29](#)
- FM Tone 1 Rate, [4-29](#)
- FM Tone 2 Ampl Percent Of Peak, [4-29](#)
- FM Tone 2 Rate, [4-30](#)
- FM Waveform, [4-30](#)
- Freq, [4-99](#)
- Freq Multiplier, [4-35](#)
- Freq Offset, [4-35](#)
- Freq Ref Off On, [4-36](#)
- Freq Ref Set, [4-36](#)
- Freq Start, [4-100](#)
- Freq Stop, [4-100](#)
- Freq&Ampl, [4-100](#)
- FSK, [4-119](#)
- Function Generator, [4-52](#)
- FWCDMA, [4-120](#)
- Goto Bottom Row, [4-100](#)
- Goto Middle Row, [4-101](#)
- Goto Row, [4-101](#)
- Goto Top Row, [4-101](#)
- Hardware Options, [4-120](#)
- Help Mode Single Cont, [4-120](#)
- High Crest Mode Off On, [4-45](#)
- HP8648A/B/C/D, [4-121](#)
- HP8656B,8657A/B, [4-121](#)
- HP8657D NADC, [4-121](#)
- HP8657D PDC, [4-122](#)
- HP8657J PHS, [4-122](#)
- HP-IB Address, [4-122](#)
- HP-IB/RS-232, [4-123](#)
- I Offset, [4-46](#)
- I/Q, [4-124](#)
- I/Q Adjustments, [4-46](#)
- I/Q Adjustments Off On, [4-46](#)
- I/Q Calibration, [4-46](#)
- I/Q Gain, [4-47](#)
- I/Q Off On, [4-47](#)
- I/Q Source, [4-47](#)
- Immediate, [4-9](#), [4-30](#), [4-52](#), [4-77](#), [4-102](#)
- Insert Item, [4-102](#)
- Insert Row, [4-102](#)
- Installed Board Info, [4-123](#)
- Instrument Adjustments, [4-123](#)
- Instrument Info/Help Mode, [4-124](#)
- Int Burst, [4-48](#)
- Int I/Q, [4-48](#)
- Internal, [4-10](#), [4-30](#), [4-77](#)
- Internal Modulation, [4-53](#)
- Internal Pulse, [4-83](#)
- Internal Square, [4-83](#)
- Inverse Video Off On, [4-124](#)
- labels, [3-8](#)
- LF Out Amplitude, [4-53](#)
- LF Out Freq, [4-53](#)
- LF Out Off On, [4-54](#)
- LF Out Period, [4-54](#)
- LF Out Source, [4-55](#)
- LF Out Start Freq, [4-55](#)
- LF Out Stop Freq, [4-56](#)
- LF Out Sweep Time, [4-56](#)
- LF Out Sweep Trigger, [4-57](#)
- LF Out Tone 1 Freq, [4-57](#)
- LF Out Tone 2 Ampl % Of Peak, [4-58](#)
- LF Out Tone 2 Freq, [4-58](#)
- LF Out Waveform, [4-59](#)
- LF Out Width, [4-59](#)
- List, [4-124](#)
- Load From Selected File, [4-102](#)
- Load List From Step Sweep, [4-103](#)
- Load/Store, [4-103](#)
- location, [3-5](#)
- Manual Mode Off On, [4-103](#)
- Manual Point, [4-103](#)
- MCDMA, [4-124](#)
- MDMOD, [4-125](#)
- MDWCDMA, [4-125](#)
- Memory Catalog, [4-124](#)
- MFCDMA, [4-125](#)
- MFWCDMA, [4-125](#)
- Mod Status Info Off On, [4-126](#)
- Mode 1 Optimize <10kHz Offset, [4-36](#)
- Mode 2 Optimize >10kHz Offset, [4-36](#)
- Modify License Key, [4-125](#)
- Modulation Catalog Types, [4-126](#)
- MTONE, [4-126](#)
- Noise, [4-10](#), [4-31](#), [4-59](#), [4-77](#)
- NVARB, [4-126](#)
- Off, [4-104](#), [4-126](#)
- Optimize Φ Noise, [4-37](#)
- Page Down, [4-104](#), [4-127](#)
- Page Up, [4-104](#), [4-127](#)
- Pattern Trigger In Polarity Neg Pos, [4-127](#)

- Phase Ref Set, [4-37](#)
- PN9 Mode Preset Normal Quick, [4-127](#)
- Point Trigger, [4-104](#)
- Power On Last Preset, [4-128](#)
- Power On/Presets, [4-128](#)
- Power Search, [4-18](#)
- Power Search Manual Auto, [4-18](#), [4-48](#)
- Power Search Reference Fixed Modulated, [4-18](#)
- Preset Language, [4-129](#)
- Preset List, [4-105](#)
- Preset Normal User, [4-129](#)
- Proceed With Reconfiguration, [4-129](#)
- Pulse, [4-60](#)
- Pulse Off On, [4-83](#)
- Pulse Rate, [4-84](#)
- Pulse Source, [4-84](#)
- Pulse Width, [4-85](#)
- Q Offset, [4-49](#)
- Quadrature Skew, [4-49](#)
- Ramp, [4-10](#), [4-31](#), [4-60](#)
- RCDMA, [4-130](#)
- Recall Ref Osc Setting, [4-130](#)
- Recall Reg, [4-87](#)
- Receive Pace None Xon, [4-130](#)
- Ref Osc Coarse, [4-118](#), [4-130](#)
- Ref Osc Fine, [4-131](#)
- Ref Oscillator Source Auto Off On, [4-37](#)
- Reference Oscillator Adjustment, [4-130](#)
- Remote Language, [4-131](#)
- Rename File, [4-131](#)
- Reset RS-232, [4-132](#)
- Restore Default Signal Polarities, [4-132](#)
- Reverse Power Protection Normal HP8648, [4-132](#)
- Revert to Default Cal Settings, [4-49](#)
- RS-232 Baud Rate, [4-133](#)
- RS-232 Echo Off On, [4-133](#)
- RS-232 Pace, [4-133](#)
- RS-232 Timeout, [4-133](#)
- RTS On, [4-134](#)
- RTS/CTS, [4-134](#)
- RTS/CTS Pacing, [4-134](#)
- RWCDMA, [4-134](#)
- Save User Preset, [4-135](#)
- SCPI, [4-135](#)
- Screen Saver Delay, [4-135](#)
- Screen Saver Mode, [4-136](#)
- Screen Saver Off On, [4-136](#)
- Select Item, [4-136](#)
- Select Reg, [4-94](#)
- Select Seq, [4-88](#), [4-95](#)
- Seq, [4-137](#)
- Shape, [4-137](#)
- Sine, [4-10](#), [4-31](#), [4-60](#), [4-77](#)
- Single Sweep, [4-105](#)
- Software Options, [4-137](#)
- Square, [4-10](#), [4-31](#), [4-60](#), [4-78](#)
- Start Frequency, [4-50](#)
- State, [4-137](#)
- Step Dwell, [4-105](#)
- Step/Knob Ratio, [4-138](#)
- Stop Frequency, [4-50](#)
- Store Ref Osc Setting, [4-138](#)
- Store To File, [4-105](#)
- Sweep, [4-106](#)
- Sweep Direction Down Up, [4-106](#)
- Sweep Repeat Single Cont, [4-106](#)
- Sweep Trigger, [4-107](#)
- Sweep Type List Step, [4-107](#)
- Swept Sine, [4-11](#), [4-31](#), [4-61](#), [4-78](#)
- Symbol Sync Out Polarity Neg Pos, [4-138](#)
- Symbol Sync Polarity Neg Pos, [4-138](#)
- Transmit Pace None Xon, [4-139](#)
- Triangle, [4-11](#), [4-32](#), [4-61](#), [4-78](#)
- Trigger In Polarity Neg Pos, [4-11](#), [4-32](#), [4-61](#), [4-78](#)
- Trigger Key, [4-12](#), [4-32](#), [4-62](#), [4-79](#), [4-107](#)
- Trigger Out Polarity Neg Pos, [4-12](#), [4-33](#), [4-62](#), [4-79](#), [4-108](#)
- Unselect All Items, [4-117](#)
- Unselect Item, [4-117](#)
- UWCDMA, [4-139](#)
- View Next Error Message, [4-139](#)
- View Previous Error Message, [4-140](#)
- WCDMA, [4-140](#)
- White Pixels Screen test, [4-140](#)
- software option
 - enabling, [2-15](#)
- Software Options softkey, [4-137](#)
- Square softkey, [4-10](#), [4-31](#), [4-60](#), [4-78](#)
- standby LED, [3-5](#)
- standby symbol, [6-3](#)
- Start Frequency softkey, [4-50](#)
- State softkey, [4-137](#)
- statement of compliance, [6-5](#)
- Step Dwell softkey, [4-105](#)
- step sweep
 - configuring, [2-9](#)
 - creating, [2-9](#)
- step sweep (continuous)
 - turning on, [2-10](#)
- step sweep dwell time, [4-105](#)
- step sweep points, [4-96](#)
- step sweep, creating, [2-9](#)
- Step/Knob Ratio softkey, [4-138](#)

- Stop Frequency softkey, [4-50](#)
 - Store Ref Osc Setting softkey, [4-138](#)
 - Store To File softkey, [4-105](#)
 - sweep
 - creating, [2-9](#)
 - list not recalled, [2-17](#)
 - list points, editing, [2-10](#)
 - stepped, configuring, [2-9](#)
 - triggering point-by-point, [4-104](#)
 - turning off, [4-104](#)
 - SWEEP annunciator, [3-10](#)
 - Sweep Direction Down Up softkey, [4-106](#)
 - sweep list dwell time, incorrect, [2-18](#)
 - sweep mode
 - turning off, [2-17](#)
 - SWEEP OUT connector, [3-14](#)
 - Sweep Repeat Single Cont softkey, [4-106](#)
 - Sweep softkey, [4-106](#)
 - sweep trigger
 - bus, [4-97](#)
 - external, [4-99](#)
 - immediate, [4-102](#)
 - trigger key, [4-107](#)
 - Sweep Trigger softkey, [4-107](#)
 - Sweep Type List Step softkey, [4-107](#)
 - Sweep/List hardkey, [4-96](#)
 - Swept Sine softkey, [4-11](#), [4-31](#), [4-61](#), [4-78](#)
 - switch, power, [3-5](#)
 - SYMBOL SYNC input connector, [3-7](#)
 - SYMBOL SYNC OUT connector, [3-13](#)
 - Symbol Sync Out Polarity Neg Pos softkey, [4-138](#)
 - Symbol Sync Polarity Neg Pos softkey, [4-138](#)
- ## T
- T annunciator, [3-11](#)
 - talk mode annunciator, [3-11](#)
 - temperature requirements, [1-4](#)
 - text area, [3-9](#)
 - Transmit Pace None Xon softkey, [4-139](#)
 - Triangle softkey, [4-11](#), [4-32](#), [4-61](#), [4-78](#)
 - Trigger hardkey, [3-3](#), [4-109](#)
 - TRIGGER IN connector, [3-14](#)
 - Trigger In Polarity Neg Pos softkey, [4-11](#), [4-32](#), [4-61](#), [4-78](#)
 - Trigger Key softkey, [4-12](#), [4-32](#), [4-62](#), [4-79](#), [4-107](#)
 - TRIGGER OUT connector, [3-14](#)
 - Trigger Out Polarity Neg Pos softkey, [4-12](#), [4-33](#), [4-62](#), [4-79](#), [4-108](#)
 - troubleshooting, [2-16](#)
 - can't turn off help mode, [2-18](#)
 - empty registers, [2-17](#)
 - incorrect LF output signal, [2-18](#)
 - incorrect register contents, [2-17](#)
 - incorrect sweep list dwell time, [2-18](#)
 - no modulation at RF output, [2-17](#)
 - no RF output, [2-16](#)
 - optional features not working, [2-16](#)
 - power supply shut down, [2-17](#)
 - RF output too low, [2-16](#)
 - signal generator locked up, [2-19](#)
 - sweep list not recalled, [2-17](#)
 - turning off sweep mode, [2-17](#)
 - turning on a step sweep (continuous), [2-10](#)
 - turning on amplitude modulation, [2-6](#)
 - turning on frequency modulation, [2-8](#)
 - turning on list sweep for a single sweep, [2-11](#)
- ## U
- UNLEVEL annunciator, [3-11](#)
 - UNLOCK annunciator, [3-11](#)
 - Unselect All Items softkey, [4-117](#)
 - Unselect Item softkey, [4-117](#)
 - up arrow key, [4-20](#)
 - Update in Remote softkey
 - softkey, Update in Remote, [4-139](#)
 - usage requirements, [1-4](#)
 - user files
 - copying, [5-4](#)
 - deleting, [5-4](#)
 - renaming, [5-4](#)
 - viewing, [5-3](#)
 - Utility hardkey, [4-111](#)
 - UWCDMA softkey, [4-139](#)
- ## V
- ventilation, [1-4](#)
 - ventilation requirements, [1-4](#)
 - verification, operation, [1-7](#)
 - View Next Error Message softkey, [4-139](#)
 - View Previous Error Message softkey, [4-140](#)
 - volatile memory, [5-2](#)
- ## W
- warning sign, [6-2](#)
 - WCDMA softkey, [4-140](#)
 - White Pixels Screen Test softkey, [4-140](#)

